



Republic of the Philippines
DEPARTMENT OF AGRICULTURE
Regional Field Office No. 5
San Agustin, Pili, Camarines Sur 4418

Labor and Materials for the Construction of Pili Post Harvest Facility

₱ 2,475,000.00

15-INFRA-HVCDP-2023

Fifth Edition

June 22, 2023

TABLE OF CONTENTS

GLOSSARY OF	4
TERMS, ABBREVIATIONS, AND ACRONYMS	4
SECTION I. INVITATION TO BID	7
SECTION II. INSTRUCTIONS TO BIDDERS	11
1. Scope of Bid	12
2. Funding Information.....	12
3. Bidding Requirements.....	12
4. Corrupt, Fraudulent, Collusive, Coercive, and Obstructive Practices.....	12
5. Eligible Bidders	13
6. Origin of Associated Goods.....	13
7. Subcontracts.....	13
8. Pre-Bid Conference.....	13
9. Clarification and Amendment of Bidding Documents	13
10. Documents Comprising the Bid: Eligibility and Technical Components	14
11. Documents Comprising the Bid: Financial Component	14
12. Alternative Bids.....	14
13. Bid Prices	15
14. Bid and Payment Currencies	15
15. Bid Security.....	15
16. Sealing and Marking of Bids.....	15
17. Deadline for Submission of Bids	16
18. Opening and Preliminary Examination of Bids.....	16
19. Detailed Evaluation and Comparison of Bids.....	16
20. Post Qualification	17
21. Signing of the Contract.....	17
SECTION III. BID DATA SHEET	18
SECTION IV. GENERAL CONDITIONS OF CONTRACT	21
1. Scope of Contract.....	22
2. Sectional Completion of Works	22
3. Possession of Site	22
4. The Contractor's Obligations	22
5. Performance Security	23

6.	Site Investigation Reports.....	23
7.	Warranty.....	23
8.	Liability of the Contractor.....	23
9.	Termination for Other Causes.....	23
10.	Day works.....	24
11.	Program of Work.....	24
12.	Instructions, Inspections and Audits.....	24
13.	Advance Payment.....	24
14.	Progress Payments	24
15.	Operating and Maintenance Manuals.....	24
SECTION V. SPECIAL CONDITIONS OF CONTRACT		26
SECTION VI. SPECIFICATIONS		29
SECTION VII. DRAWINGS.....		30
SECTION VIII. BILL OF QUANTITIES		31
SECTION IX. CHECKLIST OF TECHNICAL AND FINANCIAL DOCUMENTS.....		32

Glossary of Terms, Abbreviations, and Acronyms

ABC – Approved Budget for the Contract.

ARCC – Allowable Range of Contract Cost.

BAC – Bids and Awards Committee.

Bid – A signed offer or proposal to undertake a contract submitted by a bidder in response to and in consonance with the requirements of the bidding documents. Also referred to as *Proposal* and *Tender*. (2016 revised IRR, Section 5[c])

Bidder – Refers to a contractor, manufacturer, supplier, distributor and/or consultant who submits a bid in response to the requirements of the Bidding Documents. (2016 revised IRR, Section 5[d])

Bidding Documents – The documents issued by the Procuring Entity as the bases for bids, furnishing all information necessary for a prospective bidder to prepare a bid for the Goods, Infrastructure Projects, and/or Consulting Services required by the Procuring Entity. (2016 revised IRR, Section 5[e])

BIR – Bureau of Internal Revenue.

BSP – Bangko Sentral ng Pilipinas.

CDA – Cooperative Development Authority.

Consulting Services – Refer to services for Infrastructure Projects and other types of projects or activities of the GOP requiring adequate external technical and professional expertise that are beyond the capability and/or capacity of the GOP to undertake such as, but not limited to: (i) advisory and review services; (ii) pre-investment or feasibility studies; (iii) design; (iv) construction supervision; (v) management and related services; and (vi) other technical services or special studies. (2016 revised IRR, Section 5[i])

Contract – Refers to the agreement entered into between the Procuring Entity and the Supplier or Manufacturer or Distributor or Service Provider for procurement of Goods and Services; Contractor for Procurement of Infrastructure Projects; or Consultant or Consulting Firm for Procurement of Consulting Services; as the case may be, as recorded in the Contract Form signed by the parties, including all attachments and appendices thereto and all documents incorporated by reference therein.

Contractor – is a natural or juridical entity whose proposal was accepted by the Procuring Entity and to whom the Contract to execute the Work was awarded. Contractor as used in these Bidding Documents may likewise refer to a supplier, distributor, manufacturer, or consultant.

CPI – Consumer Price Index.

DOLE – Department of Labor and Employment.

DTI – Department of Trade and Industry.

Foreign-funded Procurement or Foreign-Assisted Project –Refers to procurement whose funding source is from a foreign government, foreign or international financing institution as specified in the Treaty or International or Executive Agreement. (2016 revised IRR, Section 5[b]).

GFI – Government Financial Institution.

GOCC –Government-owned and/or –controlled corporation.

Goods – Refer to all items, supplies, materials and general support services, except Consulting Services and Infrastructure Projects, which may be needed in the transaction of public businesses or in the pursuit of any government undertaking, project or activity, whether in the nature of equipment, furniture, stationery, materials for construction, or personal property of any kind, including non-personal or contractual services such as the repair and maintenance of equipment and furniture, as well as trucking, hauling, janitorial, security, and related or analogous services, as well as procurement of materials and supplies provided by the Procuring Entity for such services. The term “related” or “analogous services” shall include, but is not limited to, lease or purchase of office space, media advertisements, health maintenance services, and other services essential to the operation of the Procuring Entity. (2016 revised IRR, Section 5[r])

GOP – Government of the Philippines.

Infrastructure Projects – Include the construction, improvement, rehabilitation, demolition, repair, restoration or maintenance of roads and bridges, railways, airports, seaports, communication facilities, civil works components of information technology projects, irrigation, flood control and drainage, water supply, sanitation, sewerage and solid waste management systems, shore protection, energy/power and electrification facilities, national buildings, school buildings, hospital buildings, and other related construction projects of the government. Also referred to as *civil works or works*. (2016 revised IRR, Section 5[u])

LGUs – Local Government Units.

NFCC – Net Financial Contracting Capacity.

NGA – National Government Agency.

PCAB – Philippine Contractors Accreditation Board.

PhilGEPS - Philippine Government Electronic Procurement System.

Procurement Project – refers to a specific or identified procurement covering goods, infrastructure project or consulting services. A Procurement Project shall be described, detailed, and scheduled in the Project Procurement Management Plan prepared by the

agency which shall be consolidated in the procuring entity's Annual Procurement Plan.
(GPPB Circular No. 06-2019 dated 17 July 2019)

PSA – Philippine Statistics Authority.

SEC – Securities and Exchange Commission.

SLCC – Single Largest Completed Contract.

UN – United Nations.

Section I. Invitation to Bid



Republic of the Philippines

DEPARTMENT OF AGRICULTURE

REGIONAL FIELD OFFICE NO. 5

San Agustin, Pili, Camarines Sur, 4418

<http://bicol.da.gov.ph>

INVITATION TO BID

Labor and Materials for the Construction of Pili Post Harvest Facility

- The **Department of Agriculture Regional Field Office No. 5**, through the **General Appropriations Act (GAA) for CY 2023 HVCDP** intends to apply the sum of **TWO MILLION FOUR HUNDRED SEVENTY-FIVE THOUSAND PESOS (₱ 2,475,000.00)** being the ABC to payments under the contract for **ITB No. 15-INFRA-HVCDP-2023**, as follows:

Description	ABC (Php) (inclusive of VAT)	Funding Source
Pili Post Harvest Facility	2,475,000.00	GAA 2023 HVCDP

Bids received in excess of the ABC shall be automatically rejected at bid opening.

- The **DA RFO5** now invites bids for the following:

Description	Location of Project	QTY	Specifications	Unit Cost	Total Cost	Completion of Works
Pili Post Harvest Facility	Taguytuy, Malinao, Albay	1 lot	Pls. see attached Plan and BOQ for your reference Note: <ul style="list-style-type: none"> Specs should conform to detailed engineering design 	2,475,000.00	2,475,000.00	120 calendar days upon receipt of NTP

- Bidding will be conducted through open competitive bidding procedures using non-discretionary "*pass/fail*" criterion as specified in the 2016 revised Implementing Rules and Regulations (IRR) of Republic Act (RA) No. 9184.
- Interested Bidders may obtain further information from **DA RFO 5** and inspect the Bidding Documents at the address given below during **Mondays – Fridays, 8:00 AM to 5:00 PM except for Holidays, Saturdays and Sundays**.

5. A complete set of Bidding Documents may be acquired by interested Bidders on **June 22 – July 14, 2023 (9:00 AM)** from the given address and website(s) below and upon payment of the applicable fee for the Bidding Documents, pursuant to the latest Guidelines issued by the GPPB. The cost of the bidding document shall be on per lot basis. Should the prospective bidder participate in two (2) or more items, the cost of the bidding documents shall be based on the sum of the ABCs of the items to be bid:

Lot No.	Description	AMOUNT (in PhP)	Cost/Price of Bid Documents (cash payment only) (Php)
1	Pili Post Harvest Facility	2,475,000.00	5,000.00

The Procuring Entity shall allow the bidder to present its proof of payment for the fees.

6. The **DA RFO 5** will hold a **Pre-Bid Conference on June 30, 2023; 10:00 AM at Sta. Catalina Hall (3rd Floor), Operations Building DA RFO 5, San Agustin, Pili, Camarines Sur**, which shall be open to prospective bidders.
7. Bids must be duly received by the BAC Secretariat through manual submission at the office address indicated below, on or before **July 14, 2023; 9:00 AM**. Late bids shall not be accepted.
8. All bids must be accompanied by a bid security in any of the acceptable forms and in the amount stated in **ITB** Clause 16.
9. **Bid opening shall be on July 14, 2023; 10:00 AM at the given address below at Sta. Catalina Hall (3rd Floor), Operations Building DA RFO 5, San Agustin, Pili, Camarines Sur** and/or through teleconferencing/webcasting via ZOOM. Bids will be opened in the presence of the bidders' representatives who choose to attend the activity.
10. In case of a tie Bid, the BAC will conduct the Guidelines on the Use of Non-Discretionary / Non-Discriminatory Selection criteria as Tie Breaking Method thru DRAW LOTS in case of two or more Bidders are determined and declared as the Lowest Calculated and Responsive Bidder (LCRB) (GPPB CIRCULAR NO.06-2005)
11. The **DA RFO 5** reserves the right to reject any and all bids, declare a failure of bidding, or not award the contract at any time prior to contract award in accordance with Sections 35.6 and 41 of the 2016 revised IRR of RA No. 9184, without thereby incurring any liability to the affected bidder or bidders.
12. For further information, please refer to:

BAC Secretariat Office
Department of Agriculture, Regional Field Office No. 5

San Agustin, Pili, Camarines Sur 4418
Email Address: bacrfo5@gmail.com

For Downloading of Bidding Documents: bicol.da.gov.ph .

June 20, 2023, San Agustin, Pili, Camarines Sur

LORENZO L. ALVINA
Chief, Integrated Laboratories Division
Chairman, Bids and Award Committee

Section II. Instructions to Bidders

1. Scope of Bid

The Procuring Entity, Department of Agriculture Regional Field Office No. 5 Invites Bids for the **Labor and Materials for the Construction of Pili Post Harvest Facility** Project Identification Number **15-INFRA-HVCDP-2023**.

The Procurement Project (referred to herein as “Project”) is composed of **One (1) LOT**, the details of which are described in Section VII (Technical Specifications).

2. Funding Information

2.1. The GOP through the source of funding as indicated below **General Appropriations Act (GAA) for 2023 HVCDP** in the amount of **TWO MILLION FOUR HUNDRED SEVENTY-FIVE THOUSAND PESOS (₱ 2,475,000.00)**.

- a. The source of funding is NGA, the General Appropriations Act or Special Appropriations

3. Bidding Requirements

The Bidding for the Project shall be governed by all the provisions of RA No. 9184 and its 2016 revised IRR, including its Generic Procurement Manual and associated policies, rules and regulations as the primary source thereof, while the herein clauses shall serve as the secondary source thereof.

Any amendments made to the IRR and other GPPB issuances shall be applicable only to the ongoing posting, advertisement, or invitation to bid by the BAC through the issuance of a supplemental or bid bulletin.

The Bidder, by the act of submitting its Bid, shall be deemed to have inspected the site, determined the general characteristics of the contracted Works and the conditions for this Project, such as the location and the nature of the work; (b) climatic conditions; (c) transportation facilities; (c) nature and condition of the terrain, geological conditions at the site communication facilities, requirements, location and availability of construction aggregates and other materials, labor, water, electric power and access roads; and (d) other factors that may affect the cost, duration and execution or implementation of the contract, project, or work and examine all instructions, forms, terms, and project requirements in the Bidding Documents.

4. Corrupt, Fraudulent, Collusive, Coercive, and Obstructive Practices

The Procuring Entity, as well as the Bidders and Contractors, shall observe the highest standard of ethics during the procurement and execution of the contract. They or through an agent shall not engage in corrupt, fraudulent, collusive,

coercive, and obstructive practices defined under Annex “I” of the 2016 revised IRR of RA No. 9184 or other integrity violations in competing for the Project.

5. Eligible Bidders

5.1. Only Bids of Bidders found to be legally, technically, and financially capable will be evaluated.

5.2. **The Bidder must have an experience of having completed a Single Largest Completed Contract (SLCC) that is similar to this Project, equivalent to at least fifty percent (50%) of the ABC in the amount of ₱ 1,237,500.00.**

A contract is considered to be “similar” to the contract to be bid if it has the major categories of work stated in the **BDS**.

5.3. For Foreign-funded Procurement, the Procuring Entity and the foreign government/foreign or international financing institution may agree on another track record requirement, as specified in the Bidding Document prepared for this purpose.

5.4. The Bidders shall comply with the eligibility criteria under Section 23.4.2 of the 2016 IRR of RA No. 9184.

6. Origin of Associated Goods

There is no restriction on the origin of Goods other than those prohibited by a decision of the UN Security Council taken under Chapter VII of the Charter of the UN.

7. Subcontracts

7.1. The Bidder may subcontract portions of the Project to the extent allowed by the Procuring Entity as stated herein, but in no case more than fifty percent (50%) of the Project.

a. Subcontracting is not allowed.

8. Pre-Bid Conference

The Procuring Entity will hold a pre-bid conference for this Project on the specified date and time and either at its physical address and/or through videoconferencing/webcasting as indicated in paragraph 6 of the **IB**.

9. Clarification and Amendment of Bidding Documents

Prospective bidders may request for clarification on and/or interpretation of any part of the Bidding Documents. Such requests must be in writing and received by the Procuring Entity, either at its given address or through electronic mail indicated in the **IB**, at least ten (10) calendar days before the deadline set for the submission and receipt of Bids.

10. Documents Comprising the Bid: Eligibility and Technical Components

- 10.1. The first envelope shall contain the eligibility and technical documents of the Bid as specified in **Section IX. Checklist of Technical and Financial Documents**.
- 10.2. If the eligibility requirements or statements, the bids, and all other documents for submission to the BAC are in foreign language other than English, it must be accompanied by a translation in English, which shall be authenticated by the appropriate Philippine foreign service establishment, post, or the equivalent office having jurisdiction over the foreign bidder's affairs in the Philippines. For Contracting Parties to the Apostille Convention, only the translated documents shall be authenticated through an apostille pursuant to GPPB Resolution No. 13-2019 dated 23 May 2019. The English translation shall govern, for purposes of interpretation of the bid.
- 10.3. A valid PCAB License is required, and in case of joint ventures, a valid special PCAB License, and registration for the type and cost of the contract for this Project. Any additional type of Contractor license or permit shall be indicated in the **BDS**.
- 10.4. A List of Contractor's key personnel (e.g., Project Manager, Project Engineers, Materials Engineers, and Foremen) assigned to the contract to be bid, with their complete qualification and experience data shall be provided. These key personnel must meet the required minimum years of experience set in the **BDS**.
- 10.5. A List of Contractor's major equipment units, which are owned, leased, and/or under purchase agreements, supported by proof of ownership, certification of availability of equipment from the equipment lessor/vendor for the duration of the project, as the case may be, must meet the minimum requirements for the contract set in the **BDS**.

11. Documents Comprising the Bid: Financial Component

- 11.1. The second bid envelope shall contain the financial documents for the Bid as specified in **Section IX. Checklist of Technical and Financial Documents**.
- 11.2. Any bid exceeding the ABC indicated in paragraph 1 of the **IB** shall not be accepted.
- 11.3. For Foreign-funded procurement, a ceiling may be applied to bid prices provided the conditions are met under Section 31.2 of the 2016 revised IRR of RA No. 9184.

12. Alternative Bids

Bidders shall submit offers that comply with the requirements of the Bidding Documents, including the basic technical design as indicated in the drawings and specifications. Unless there is a value engineering clause in the **BDS**, alternative Bids shall not be accepted.

13. Bid Prices

All bid prices for the given scope of work in the Project as awarded shall be considered as fixed prices, and therefore not subject to price escalation during contract implementation, except under extraordinary circumstances as determined by the NEDA and approved by the GPPB pursuant to the revised Guidelines for Contract Price Escalation guidelines.

14. Bid and Payment Currencies

14.1. Bid prices may be quoted in the local currency or tradeable currency accepted by the BSP at the discretion of the Bidder. However, for purposes of bid evaluation, Bids denominated in foreign currencies shall be converted to Philippine currency based on the exchange rate as published in the BSP reference rate bulletin on the day of the bid opening.

14.2. Payment of the contract price shall be made in:

- a. Philippine Pesos.

15. Bid Security

15.1. The Bidder shall submit a Bid Securing Declaration or any form of Bid Security in the amount indicated in the **BDS**, which shall be not less than the percentage of the ABC in accordance with the schedule in the **BDS**.

15.2. The Bid and bid security shall be valid until **November 11, 2023**. Any bid not accompanied by an acceptable bid security shall be rejected by the Procuring Entity as non-responsive.

16. Sealing and Marking of Bids

Each Bidder shall submit one (1) copy of the Original and three (3) copies copy of the first and second components of its Bid.

Sealed Original, Copy 1, Copy 2 & 3 in one (1) Single Envelope

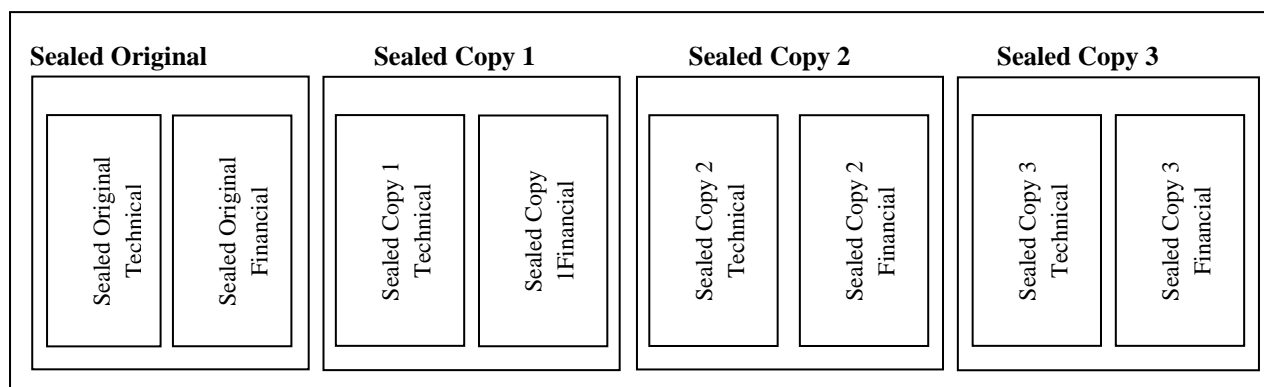

All copies shall be marked Certified True Copy & signed by the bidder or its duly authorized representative.

Additional instructions: All copies must be marked with index/ear tabs or side-end tabs to identify the page components and shall be properly addressed to the **BAC Chairperson**.

The Procuring Entity may request additional hard copies and/or electronic copies of the Bid. However, failure of the Bidders to comply with the said request shall not be a ground for disqualification.

If the Procuring Entity allows the submission of bids through online submission to the given website or any other electronic means, the Bidder shall submit an electronic copy of its Bid, which must be digitally signed. An electronic copy that cannot be opened or is corrupted shall be considered non-responsive and, thus, automatically disqualified.

17. Deadline for Submission of Bids

The Bidders shall submit on the specified date and time and either at its physical address or through online submission as indicated in paragraph 7 of the **IB**.

18. Opening and Preliminary Examination of Bids

18.1. The BAC shall open the Bids in public at the time, on the date, and at the place specified in paragraph 9 of the **IB**. The Bidders' representatives who are present shall sign a register evidencing their attendance. In case videoconferencing, webcasting or other similar technologies will be used, attendance of participants shall likewise be recorded by the BAC Secretariat.

In case the Bids cannot be opened as scheduled due to justifiable reasons, the rescheduling requirements under Section 29 of the 2016 revised IRR of RA No. 9184 shall prevail.

18.2. The preliminary examination of Bids shall be governed by Section 30 of the 2016 revised IRR of RA No. 9184.

19. Detailed Evaluation and Comparison of Bids

19.1. The Procuring Entity's BAC shall immediately conduct a detailed evaluation of all Bids rated "*passed*" using non-discretionary pass/fail criteria. The BAC shall consider the conditions in the evaluation of Bids under Section 32.2 of 2016 revised IRR of RA No. 9184.

19.2. If the Project allows partial bids, all Bids and combinations of Bids as indicated in the **BDS** shall be received by the same deadline and opened and evaluated simultaneously so as to determine the Bid or combination of Bids offering the lowest calculated cost to the Procuring Entity. Bid Security as required by **ITB** Clause 16 shall be submitted for each contract (lot) separately.

19.3. In all cases, the NFCC computation pursuant to Section 23.4.2.6 of the 2016 revised IRR of RA No. 9184 must be sufficient for the total of the ABCs for all the lots participated in by the prospective Bidder.

20. Post Qualification

Within a non-extendible period of five (5) calendar days from receipt by the Bidder of the notice from the BAC that it submitted the Lowest Calculated Bid, the Bidder shall submit its latest income and business tax returns filed and paid through the BIR Electronic Filing and Payment System (eFPS), and other appropriate licenses and permits required by law and stated in the **BDS**.

21. Signing of the Contract

The documents required in Section 37.2 of the 2016 revised IRR of RA No. 9184 shall form part of the Contract. Additional Contract documents are indicated in the **BDS**.

Section III. Bid Data Sheet

Bid Data Sheet

ITB Clause																						
5.2	<p>For this purpose, contracts similar to the Project shall be:</p> <p style="margin-left: 40px;">a. Any Agricultural Purpose Building</p> <p style="margin-left: 40px;">b. Completed within <i>Five (5) years</i> prior to the deadline for the submission and receipt of bids.</p>																					
7.1	<i>[Specify the portions of Works and the maximum percentage allowed to be subcontracted, which shall not be significant or material components of the Project as determined by the Procuring Entity.]</i>																					
10.3	Valid PCAB License																					
10.4	<p>The key personnel must meet the required minimum years of experience set below:</p> <table style="width: 100%; border-collapse: collapse;"> <thead> <tr> <th style="text-align: left;"><u>Key Personnel</u></th> <th style="text-align: left;"><u>General Experience</u></th> <th style="text-align: left;"><u>Relevant Experience</u></th> </tr> </thead> <tbody> <tr> <td>1. Agricultural Engineer</td> <td>5 years and above</td> <td>Agricultural Engineering</td> </tr> <tr> <td>2. Project Engineer</td> <td>5 years and above</td> <td>A Civil/Structural Engineer, Experienced & handled different construction projects similar to dam or water impounding projects</td> </tr> <tr> <td>3. Materials Engineer</td> <td>5 years and above</td> <td></td> </tr> <tr> <td>4. Safety and Health Officer</td> <td>5 years and above</td> <td>Monitored and controlled safety compliance</td> </tr> <tr> <td>5. Foreman</td> <td>5 years and above</td> <td>Management and Technical Experience/Foreman Experience</td> </tr> <tr> <td>6. Skilled and Common Labor</td> <td>5 years and above</td> <td></td> </tr> </tbody> </table> <p>SF 46 must be Notarized SF 47</p>	<u>Key Personnel</u>	<u>General Experience</u>	<u>Relevant Experience</u>	1. Agricultural Engineer	5 years and above	Agricultural Engineering	2. Project Engineer	5 years and above	A Civil/Structural Engineer, Experienced & handled different construction projects similar to dam or water impounding projects	3. Materials Engineer	5 years and above		4. Safety and Health Officer	5 years and above	Monitored and controlled safety compliance	5. Foreman	5 years and above	Management and Technical Experience/Foreman Experience	6. Skilled and Common Labor	5 years and above	
<u>Key Personnel</u>	<u>General Experience</u>	<u>Relevant Experience</u>																				
1. Agricultural Engineer	5 years and above	Agricultural Engineering																				
2. Project Engineer	5 years and above	A Civil/Structural Engineer, Experienced & handled different construction projects similar to dam or water impounding projects																				
3. Materials Engineer	5 years and above																					
4. Safety and Health Officer	5 years and above	Monitored and controlled safety compliance																				
5. Foreman	5 years and above	Management and Technical Experience/Foreman Experience																				
6. Skilled and Common Labor	5 years and above																					
10.5	<p>The minimum major equipment requirements are the following:</p> <table style="width: 100%; border-collapse: collapse;"> <thead> <tr> <th style="text-align: left;"><u>Equipment</u></th> <th style="text-align: left;"><u>Number of Units</u></th> </tr> </thead> <tbody> <tr> <td>Welding Machine</td> <td style="text-align: center;">1</td> </tr> <tr> <td>Generator</td> <td style="text-align: center;">1</td> </tr> <tr> <td>Minor Tools</td> <td style="text-align: center;">enough</td> </tr> <tr> <td>Bagger Mixer</td> <td style="text-align: center;">1</td> </tr> <tr> <td>Grinder</td> <td style="text-align: center;">1</td> </tr> <tr> <td>Concrete Vibrator</td> <td style="text-align: center;">1</td> </tr> </tbody> </table>	<u>Equipment</u>	<u>Number of Units</u>	Welding Machine	1	Generator	1	Minor Tools	enough	Bagger Mixer	1	Grinder	1	Concrete Vibrator	1							
<u>Equipment</u>	<u>Number of Units</u>																					
Welding Machine	1																					
Generator	1																					
Minor Tools	enough																					
Bagger Mixer	1																					
Grinder	1																					
Concrete Vibrator	1																					

	Bar Cutter	1										
12	<i>[Insert Value Engineering clause if allowed.]</i>											
15.1	<p>The bid security shall be in the form of a Bid Securing Declaration or any of the following forms and amounts:</p> <p>a. The amount of not less than 49,500.00, if bid security is in cash, cashier's/manager's check, bank draft/guarantee or irrevocable letter of credit;</p> <p>b. The amount of not less than 123,750.00, if bid security is in Surety Bond.</p>											
19.2	<table border="1"> <thead> <tr> <th>Description</th> <th>Location of Project</th> <th>QTY</th> <th>Specifications</th> <th>Unit Cost</th> </tr> </thead> <tbody> <tr> <td>Pili Post Harvest Facility</td> <td>Taguytuy, Malinao, Albay</td> <td>1 lot</td> <td>Pls. see attached Plan and BOQ for your reference Note: • Specs should conform to detailed engineering design</td> <td>2,475,000.00</td> </tr> </tbody> </table>		Description	Location of Project	QTY	Specifications	Unit Cost	Pili Post Harvest Facility	Taguytuy, Malinao, Albay	1 lot	Pls. see attached Plan and BOQ for your reference Note: • Specs should conform to detailed engineering design	2,475,000.00
Description	Location of Project	QTY	Specifications	Unit Cost								
Pili Post Harvest Facility	Taguytuy, Malinao, Albay	1 lot	Pls. see attached Plan and BOQ for your reference Note: • Specs should conform to detailed engineering design	2,475,000.00								
20	<i>[List licenses and permits relevant to the Project and the corresponding law requiring it, e.g. Environmental Compliance Certificate, Certification that the project site is not within a geohazard zone, etc.]</i>											
21	<p>Additional contract documents relevant to the Project that may be required by existing laws and/or the Procuring Entity:</p> <ol style="list-style-type: none"> 1. Construction schedule and S-curve 2. Manpower schedule 3. Construction methods 4. Equipment utilization schedule 5. Quality Control Program (QCP) 6. Construction safety and health program approved by the Department of Labor and Employment 7. PERT/CPM or other acceptable tools of project scheduling. 8. Performance Evaluation Report (at least very satisfactory) of Single Largest Completed Contract (SLCC) duly signed by the end-user with the approval of the Director or RTD for government contract and with the approval of the highest-ranking official for private contract. 											

Section IV. General Conditions of Contract

1. **Scope of Contract**

This Contract shall include all such items, although not specifically mentioned, that can be reasonably inferred as being required for its completion as if such items were expressly mentioned herein. All the provisions of RA No. 9184 and its 2016 revised IRR, including the Generic Procurement Manual, and associated issuances, constitute the primary source for the terms and conditions of the Contract, and thus, applicable in contract implementation. Herein clauses shall serve as the secondary source for the terms and conditions of the Contract.

This is without prejudice to Sections 74.1 and 74.2 of the 2016 revised IRR of RA No. 9184 allowing the GPPB to amend the IRR, which shall be applied to all procurement activities, the advertisement, posting, or invitation of which were issued after the effectivity of the said amendment.

2. **Sectional Completion of Works**

If sectional completion is specified in the **Special Conditions of Contract (SCC)**, references in the Conditions of Contract to the Works, the Completion Date, and the Intended Completion Date shall apply to any Section of the Works (other than references to the Completion Date and Intended Completion Date for the whole of the Works).

3. **Possession of Site**

4.1. The Procuring Entity shall give possession of all or parts of the Site to the Contractor based on the schedule of delivery indicated in the **SCC**, which corresponds to the execution of the Works. If the Contractor suffers delay or incurs cost from failure on the part of the Procuring Entity to give possession in accordance with the terms of this clause, the Procuring Entity's Representative shall give the Contractor a Contract Time Extension and certify such sum as fair to cover the cost incurred, which sum shall be paid by Procuring Entity.

4.2. If possession of a portion is not given by the above date, the Procuring Entity will be deemed to have delayed the start of the relevant activities. The resulting adjustments in contract time to address such delay may be addressed through contract extension provided under Annex "E" of the 2016 revised IRR of RA No. 9184.

4. **The Contractor's Obligations**

The Contractor shall employ the key personnel named in the Schedule of Key Personnel indicating their designation, in accordance with **ITB** Clause 10.3 and specified in the **BDS**, to carry out the supervision of the Works.

The Procuring Entity will approve any proposed replacement of key personnel only if their relevant qualifications and abilities are equal to or better than those of the personnel listed in the Schedule.

5. Performance Security

- 5.1. Within ten (10) calendar days from receipt of the Notice of Award from the Procuring Entity but in no case later than the signing of the contract by both parties, the successful Bidder shall furnish the performance security in any of the forms prescribed in Section 39 of the 2016 revised IRR.
- 5.2. The Contractor, by entering into the Contract with the Procuring Entity, acknowledges the right of the Procuring Entity to institute action pursuant to RA No. 3688 against any subcontractor be they an individual, firm, partnership, corporation, or association supplying the Contractor with labor, materials and/or equipment for the performance of this Contract.

6. Site Investigation Reports

The Contractor, in preparing the Bid, shall rely on any Site Investigation Reports referred to in the SCC supplemented by any information obtained by the Contractor.

7. Warranty

- 7.1. In case the Contractor fails to undertake the repair works under Section 62.2.2 of the 2016 revised IRR, the Procuring Entity shall forfeit its performance security, subject its property(ies) to attachment or garnishment proceedings, and perpetually disqualify it from participating in any public bidding. All payables of the GOP in his favor shall be offset to recover the costs.
- 7.2. The warranty against Structural Defects/Failures, except that occasioned-on force majeure, shall cover the period from the date of issuance of the Certificate of Final Acceptance by the Procuring Entity. Specific duration of the warranty is found in the SCC.

8. Liability of the Contractor

Subject to additional provisions, if any, set forth in the SCC, the Contractor's liability under this Contract shall be as provided by the laws of the Republic of the Philippines.

If the Contractor is a joint venture, all partners to the joint venture shall be jointly and severally liable to the Procuring Entity.

9. Termination for Other Causes

Contract termination shall be initiated in case it is determined *prima facie* by the Procuring Entity that the Contractor has engaged, before, or during the implementation of the contract, in unlawful deeds and behaviors relative to contract acquisition and implementation, such as, but not limited to corrupt, fraudulent, collusive, coercive, and obstructive practices as stated in **ITB** Clause 4.

10. Day works

Subject to the guidelines on Variation Order in Annex “E” of the 2016 revised IRR of RA No. 9184, and if applicable as indicated in the **SCC**, the Day works rates in the Contractor’s Bid shall be used for small additional amounts of work only when the Procuring Entity’s Representative has given written instructions in advance for additional work to be paid for in that way.

11. Program of Work

11.1. The Contractor shall submit to the Procuring Entity’s Representative for approval the said Program of Work showing the general methods, arrangements, order, and timing for all the activities in the Works. The submissions of the Program of Work are indicated in the **SCC**.

11.2. The Contractor shall submit to the Procuring Entity’s Representative for approval an updated Program of Work at intervals no longer than the period stated in the **SCC**. If the Contractor does not submit an updated Program of Work within this period, the Procuring Entity’s Representative may withhold the amount stated in the **SCC** from the next payment certificate and continue to withhold this amount until the next payment after the date on which the overdue Program of Work has been submitted.

12. Instructions, Inspections and Audits

The Contractor shall permit the GOP or the Procuring Entity to inspect the Contractor’s accounts and records relating to the performance of the Contractor and to have them audited by auditors of the GOP or the Procuring Entity, as may be required.

13. Advance Payment

The Procuring Entity shall, upon a written request of the Contractor which shall be submitted as a Contract document, make an advance payment to the Contractor in an amount not exceeding fifteen percent (15%) of the total contract price, to be made in lump sum, or at the most two installments according to a schedule specified in the **SCC**, subject to the requirements in Annex “E” of the 2016 revised IRR of RA No. 9184.

14. Progress Payments

The Contractor may submit a request for payment for Work accomplished. Such requests for payment shall be verified and certified by the Procuring Entity’s Representative/Project Engineer. Except as otherwise stipulated in the **SCC**, materials and equipment delivered on the site but not completely put in place shall not be included for payment.

15. Operating and Maintenance Manuals

15.1. If required, the Contractor will provide “as built” Drawings and/or operating and maintenance manuals as specified in the **SCC**.

- 15.2. If the Contractor does not provide the Drawings and/or manuals by the dates stated above, or they do not receive the Procuring Entity's Representative's approval, the Procuring Entity's Representative may withhold the amount stated in the SCC from payments due to the Contractor.

Section V. Special Conditions of Contract

Special Conditions of Contract

GCC Clause							
2	Description	Location of Project	QTY	Specifications	Unit Cost	Total Cost	Completion of Works
	Pili Post Harvest Facility	Taguytuy, Malinao, Albay	1 lot	Pls. see attached Plan and BOQ for your reference Note: <ul style="list-style-type: none"> • Specs should conform to detailed engineering design 	2,475,000.00	2,475,000.00	120 calendar days upon receipt of NTP
4.1	<i>The Intended Completion Dates are the following: 120 calendar days upon receipt of NTP</i>						
6	The site investigation reports are: <i>[list here the required site investigation reports.]</i>						
7.2	<i>In case of semi-permanent structures, such as buildings of types 1, 2, and 3 as classified under the National Building Code of the Philippines, concrete/asphalt roads, concrete river control, drainage, irrigation lined canals, river landing, deep wells, rock causeway, pedestrian overpass, and other similar semi-permanent structures: Five (5) years.</i>						
10	a. Day works are applicable at the rate shown in the Contractor's original Bid.						
11.1	The Contractor shall submit the Program of Work to the Procuring Entity's Representative within 3 days of delivery of the Notice of Award.						
11.2	The amount to be withheld for late submission of an updated Program of Work is <i>[insert amount]</i> .						
13	The amount of the advance payment is 15% of the amount of Notice of Award.						
14	<i>[If allowed by the Procuring Entity, state:]</i> Materials and equipment delivered on the site but not completely put in place shall be included for payment.						
15.1	The date by which operating and maintenance manuals are required is <i>[date]</i> .						
	The date by which "as built" drawings are required is <i>[date]</i> .						

15.2	The amount to be withheld for failing to produce “as built” drawings and/or operating and maintenance manuals by the date required is <i>[amount in local currency]</i> .
------	---

Section VI. Specifications

Section VII. Drawings

[Insert here a list of Drawings. The actual Drawings, including site plans, should be attached to this section, or annexed in a separate folder.]



REPUBLIC OF THE PHILIPPINES
DEPARTMENT OF AGRICULTURE
REGIONAL FIELD UNIT NO.5
SAN AGUSTIN, PILI CAMARINES SUR.

PROJECT TITLE

P R O P O S E D :
**CONSTRUCTION OF 1- UNIT
PILI POST HARVEST FACILITY**

LOCATION: TAGUYTOY, MALINAO, ALBAY
PREPARED BY:
RAED OFFICE



PERSPECTIVE



LOCATION MAP

<p>REPUBLIC OF THE PHILIPPINES DEPARTMENT OF AGRICULTURE REGIONAL FIELD UNIT NO.5 SAN AGUSTIN, PILI, CAVARINES SUR</p>	<p>Prepared by:</p> <p>PIA A. FELIS</p>	<p>Checked by:</p> <p>ENGR. OSCAR RAMIREZ Civil Engineer, No. 101</p>	<p>Reviewed by:</p> <p>LUIS P. LIZARZA Civil Engineer, No. 101</p>	<p>Submitted by:</p> <p>GILBERT SALCEDO Civil Engr. No. 101</p>	<p>Representing/Approved:</p> <p>LUZ R. MARCELINO With the Department</p>	<p>Approved by:</p> <p>RODOLFO FORCILLO Regional Director</p>	<p>Name of Project:</p> <p>CONSTRUCTION OF LUNIT PILI POST HARVEST FACILITY</p> <p>Location:</p> <p>TAGAYTAY, MALINAO ALIAY</p> <p>Sheet Count:</p> <p>AS SHOWN</p>	<p>Drawn by:</p> <p>11</p> <p>Scale:</p> <p>A/11</p>
	<p>DATE: _____</p>							

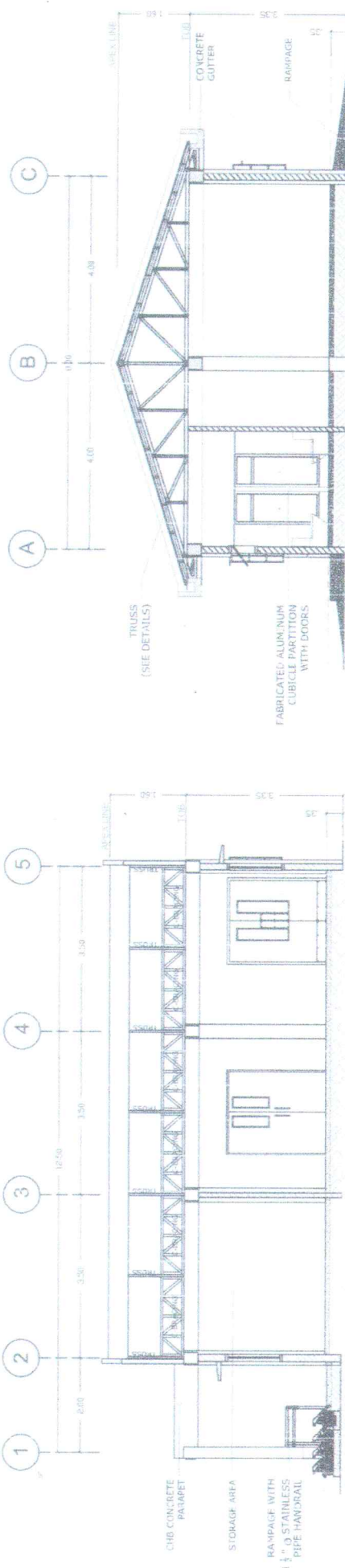

SECTION THRU B-B
SCALE 1/8" = 1'-0"

SECTION THRU A-A
SCALE 1/8" = 1'-0"

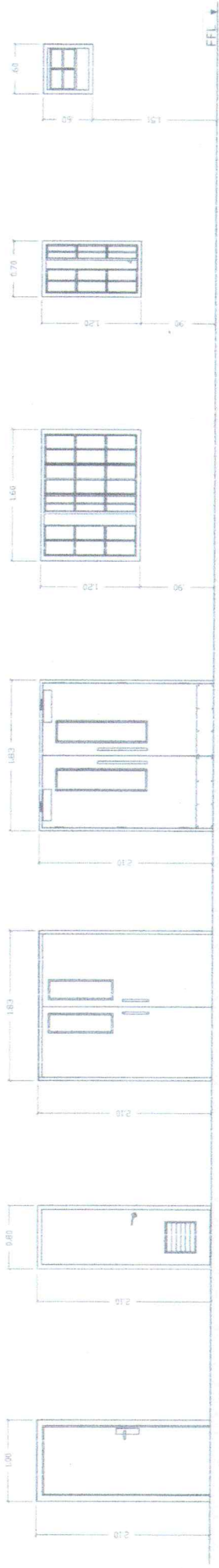

D1	SPECIFICATION	LOCKER PANEL DOOR
	ANNOTATION	D1-2 SET
	LOCATION	HAIR DRESSING STORAGE AREA

D2	SPECIFICATION	PVC FLUSH DOOR
	ANNOTATION	D1-1 SET
	LOCATION	RESTROOM

D3	SPECIFICATION	DOUBLE SWING TYPE METAL DOOR WITH TRANSLUCENT GLASS
	ANNOTATION	D3-1 SET
	LOCATION	WORKING AREA EMPLOYEES ENTRY WAY

D4	SPECIFICATION	DOUBLE PANE BRUSHED METAL DOOR
	ANNOTATION	D4-2 SETS
	LOCATION	WORKING AREA

W1	SPECIFICATION	STEEL CASEMENT WINDOW
	ANNOTATION	W1-4 SETS
	LOCATION	FRONT AND WORKING AREA

W2	SPECIFICATION	STEEL CASEMENT WINDOW
	ANNOTATION	W2-1 SET
	LOCATION	RESTROOM

W3	SPECIFICATION	AWNING TYPE WINDOW
	ANNOTATION	W3-1 SET
	LOCATION	RESTROOM

SCHEDULE OF DOORS AND WINDOWS
SCALE 1/8" = 1'-0"

Republic of the Philippines
 Department of Agriculture
 Regional Field Unit No. 5
 500 AUSTIN, P.I.L.; CAGAI-DELS SUR
 Virago ppg
 Date: 11/11/2015

Prepared by
 [Signature]
 Date: 11/11/2015

Checked by
 ENGR. OMBEL RIZ JR.
 Date: 11/11/2015

Reviewed by
 LUIS TORALBA
 Date: 11/11/2015

Approved by
 GILBERTO SALCEDO
 Date: 11/11/2015

Approved by
 ROJEL TORNILLA
 Date: 11/11/2015

Approved by
 TAGLITOP MALINAOLIBAY
 Date: 11/11/2015

Approved by
 AS SHOWN

CONSTRUCTION OF HURIT PULPST HARVEST FACILITY
 Project No. 11/11/2015
 Date: 11/11/2015

4" THK CONCRETE FLOOR
SLAB @ 10MM Ø RSB SPACED @ 0.40M
@ O.C. BOTH TOP & BOTTOM

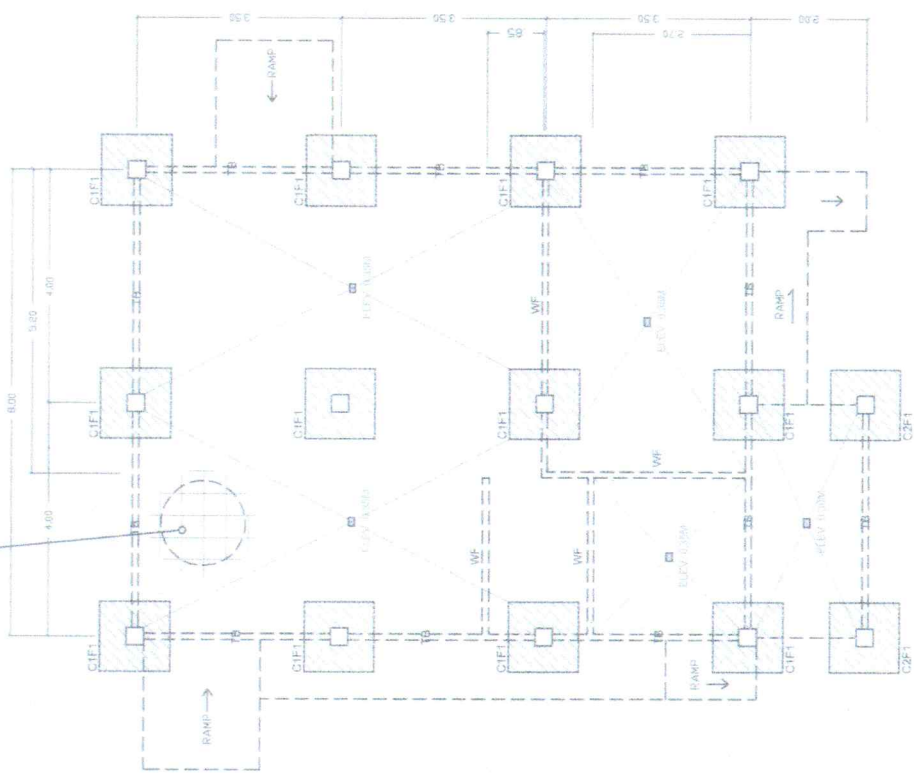

FOUNDATION LAYOUT
SCALE 1:50 M

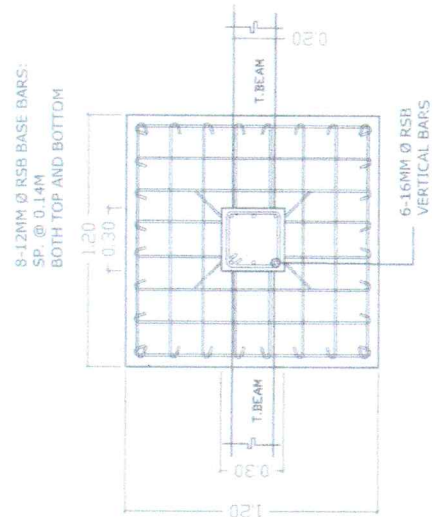

COLUMN FOOTING DETAILS
SCALE 1:25 M

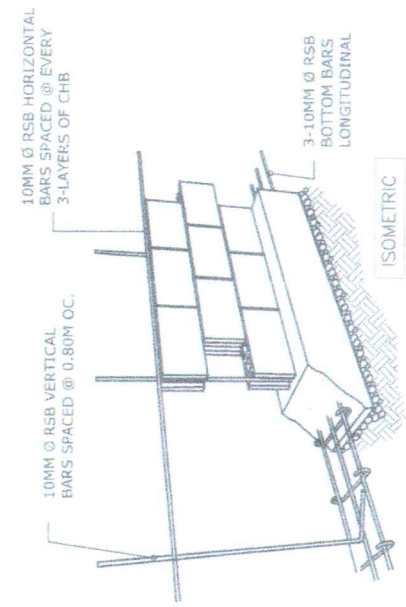

WALL FOOTING DETAILS
SCALE 1:50 M

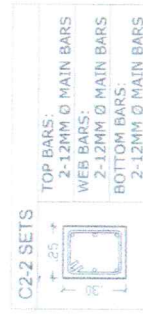
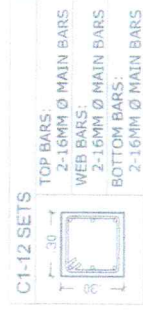
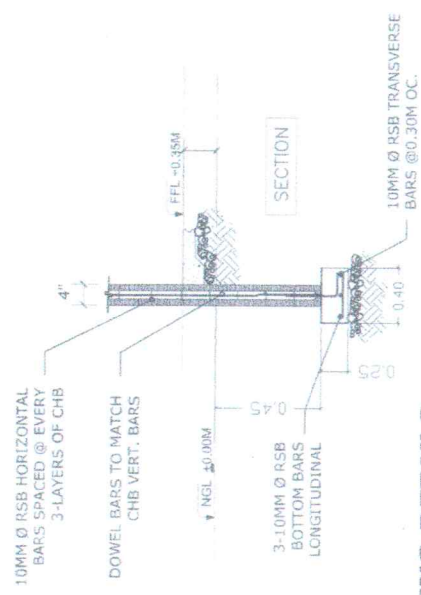

<p>REPUBLIC OF THE PHILIPPINES REGIONAL FIELD UNIT NO. 5 SAN AGUSTIN, P.I.L., CAGARIAN, SUP</p>	<p>Prepared by: <i>[Signature]</i></p>	<p>Checked by: <i>[Signature]</i> ENGR. CONRADO RUIZ JR. Civil Engineering</p>	<p>Reviewed by: <i>[Signature]</i> LUIS TOLENTINAZAR Civil Engineering</p>	<p>Submitted for: <i>[Signature]</i> GILBERT SALCEDO C.E., P.E., R.M.D.</p>	<p>Recommending Approval: <i>[Signature]</i> LUCKY MARCELLINO With an Approval</p>	<p>Approved by: <i>[Signature]</i> RODEL P. BERNIL MABLE Regional Executive Officer</p>	<p>Project No.: 5/11</p>
	<p>CONSTRUCTION OF 1-UNIT RILL POST-HARVEST FACILITY</p>	<p>Location: TAGAYTAY, MAUNAO ALBAY</p>	<p>Sheet Count: AS SHOWN</p>				

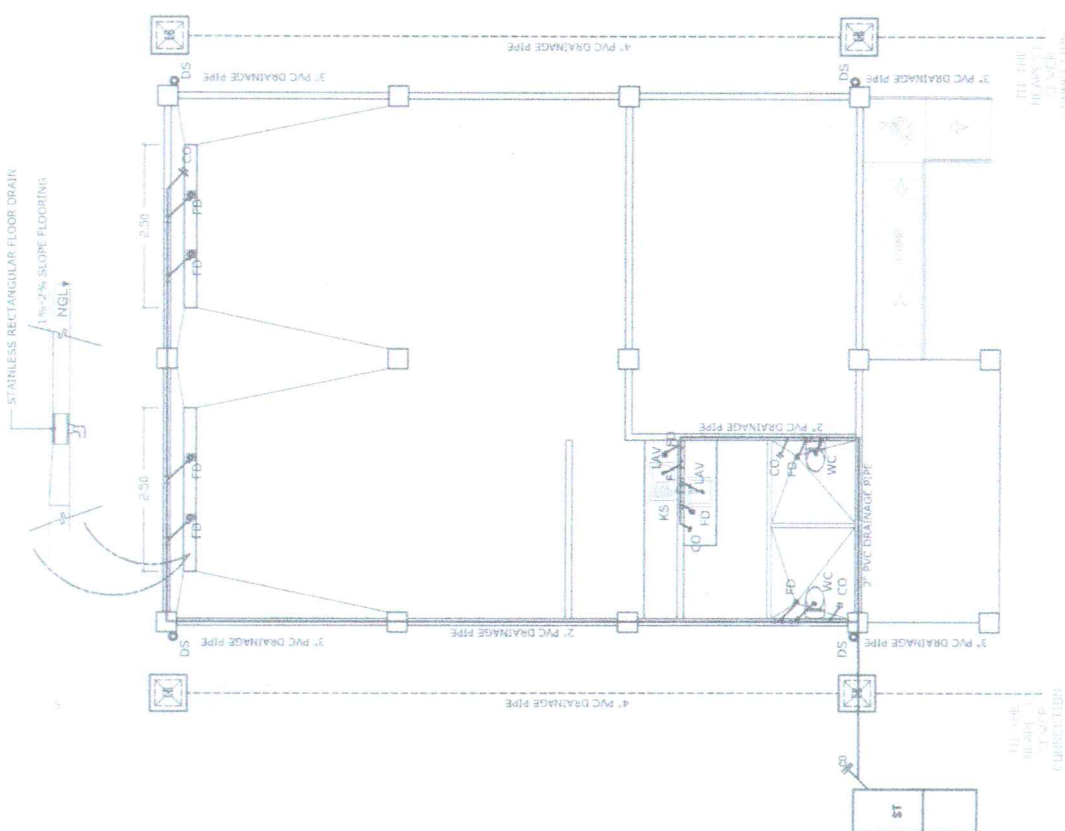

SEWER LINE LAYOUT

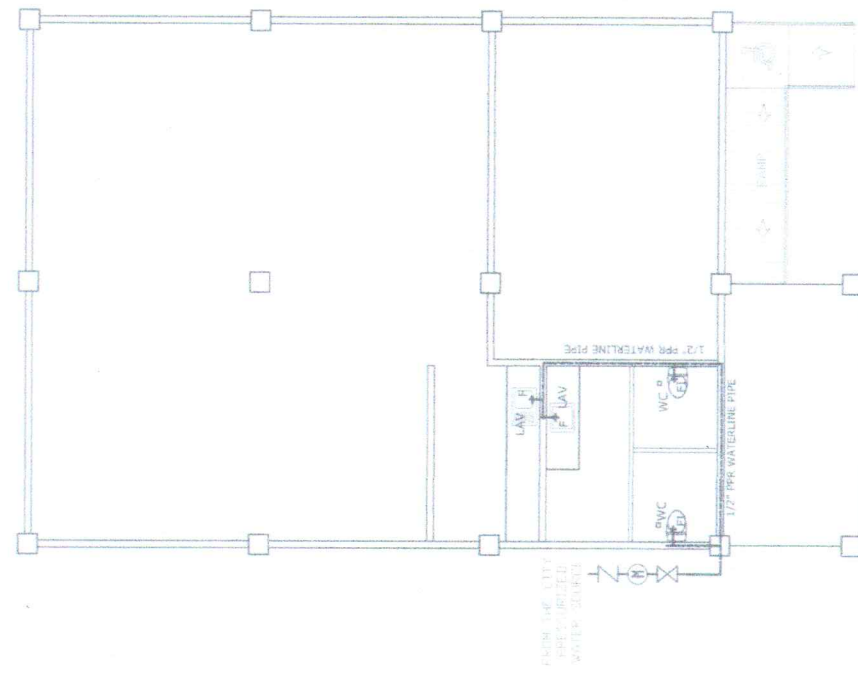

WATER LINE LAYOUT

- LEGENDS:**
- 2" PVC SANITARY/SEWER LINE
 - COLD WATER LINE
 - 4" PVC SANITARY/SEWER LINE
 - FD □ FLOOR DRAIN
 - ⊗ GATE VALVE
 - ⊥ CLEAN OUT
 - ⊥ WYE SINGLE BRANCH
 - ⊥ TEE SINGLE BRANCH
 - ⊥ ELBOW
 - ⊥ P-TRAP
 - F FAUCET
 - CB CATCH BASIN
 - DS DOWN SPOUT
 - WV WATER VALVE
 - LAV LAVATORY DRAIN
 - WC WATER CLOSET
 - FCO FLOOR CLEAN OUT
 - VSTR VENT STOCK THRU ROOF
 - ST SEPTIC TANK
 - KS KITCHEN SINK
 - ⊥ CHECK VALVE
 - ⊕ WATER METER



TO THE
HEAD OF
STOCK
CORRECTION

TO THE
HEAD OF
STOCK
CORRECTION

	REPUBLIC OF THE PHILIPPINES DEPARTMENT OF AGRICULTURE REGIONAL FIELD UNIT NO. 5 SAN AGUSTIN, PILLI, CARABANGOS, ILOCOS REGION		Project by SAN AGUSTIN	Checked by SAN AGUSTIN	Reviewed by SAN AGUSTIN	Submitted by GILBERTO SALCEDO PROJECT ENGINEER	Approved by ROBERT FORNELL REGIONAL PLANNING OFFICER	Type of Project CONSTRUCTION OF 1 UNIT PHL POST HARVEST FACILITY	Cell No. 11
	Location TAGAYTAY, MAUNAO ALBAY		Date 7/11	Scale AS SHOWN	Sheet No. 11	Title P	Date 7/11	State/Province/City ALBAY	Date 7/11

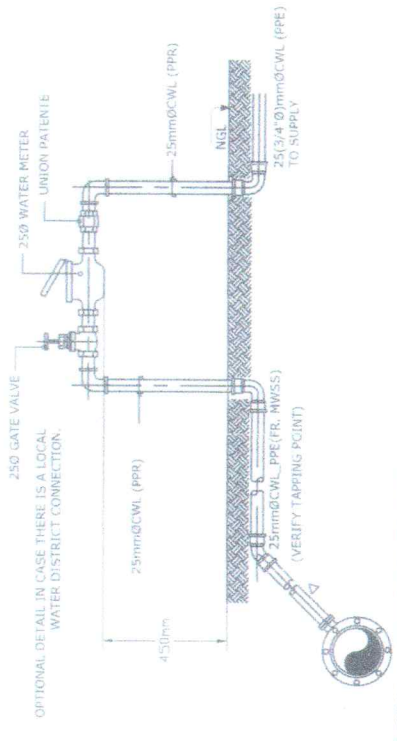

OPTIONAL DETAIL IN CASE THERE IS A LOCAL WATER DISTRICT CONNECTION.

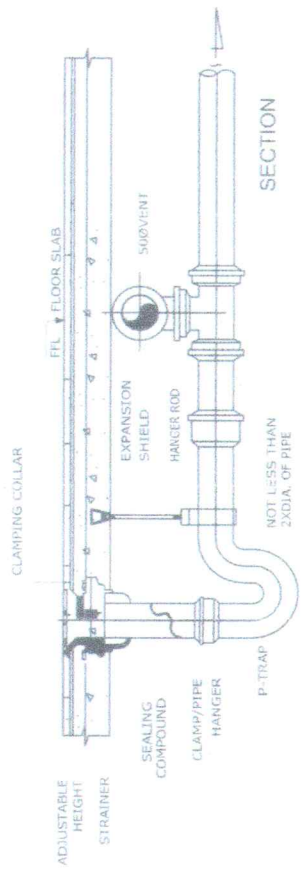

NOTE: — NO PIPE HANGER @ GROUND INSTALLATIONS.

WATER METER CONNECTION DETAIL

FLOOR DRAIN DETAIL

GENERAL NOTES:

- 01 ALL PLUMBING WORKS INCLUDED HEREIN SHALL BE EXECUTED ACCORDING TO THE PHILIPPINE PLUMBING CODE, THE NATIONAL BUILDING CODE, AND THE RULES AND REGULATION OF LOCAL GOVERNMENT AUTHORITIES CONCERNED.
- 02 COORDINATE THE DRAWING WITH OTHER RELATED DRAWINGS AND SPECIFICATIONS, THE ENGINEER SHALL BE NOTIFIED IMMEDIATELY OF ANY DISCREPANCY FOUND THEREIN.
- 03 ALL PIPES SHALL BE INSTALLED AS INDICATED ON PLANS, ANY RELOCATIONS REQUIRED FOR PROPER EXECUTIONS OF OTHER TRADES SHALL BE WITH PRIOR APPROVAL OF THE ARCHITECT OR ENGINEER.
- 04 PROPOSED SANITARY UTILITIES SHALL CONFORM TO THE ACTUAL LOCATION, DEPTH AND INVERT ELEVATION OF ALL EXISTING PIPES AND STRUCTURES AS VERIFIED BY THE CONTRACTOR.
- 05 ALL SLOPES FOR HORIZONTAL DRAINAGES SHALL MAINTAIN 1% UNLESS OTHERWISE SPECIFIED.
- 06 SIZES OF WATER SUPPLY PIPES TO FIXTURES SHALL BE IN ACCORDANCE WITH THE MANUFACTURERS INSTRUCTIONS.
- 07 THE CONTRACTOR SHALL VERIFY ALL EXISTING UTILITIES AT SITE AND COORDINATES THE WORKS WITH THE SEWER LINE EFFLUENT DISPOSAL POINT AND WATER LINE SERVICE CONNECTING POINT.
- 08 ALL PIPES SIZES ARE IN MILLIMETERS AND ALL DIMENSIONS ARE IN METERS UNLESS OTHERWISE SPECIFIED.

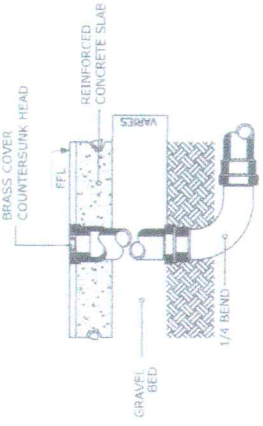
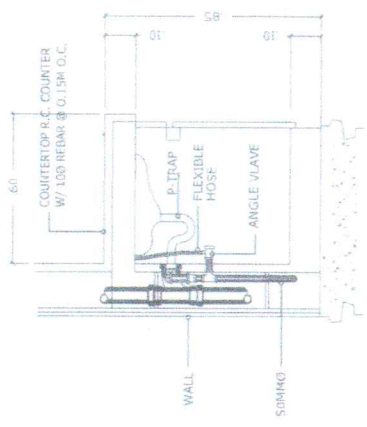

LAVATORY COUNTER DETAIL

FLOOR CLEAN OUT DETAIL

<p>REPUBLIC OF THE PHILIPPINES Department of Public Works and Highways REGIONAL FIELD UNIT NO. 5 SAN AGUSTIN, PILL. CAMARINES SUR</p>	<p>Prepared by: <i>[Signature]</i></p>	<p>Checked by: <i>[Signature]</i> ENGR. OLYMPIA QUIZIR Civil Engineer</p>	<p>Reviewed by: <i>[Signature]</i> LUISER P. HAZAR Civil Engineer</p>	<p>Submitted by: <i>[Signature]</i> GILBERT CALDERO Civil Engineer</p>	<p>Approved by: <i>[Signature]</i> ROSEL TORRILLO Professional Engineer Civil Engineering</p>	<p>Project/Contract Name: CONSTRUCTION OF 1-UNIT PILL POST HARVEST FACILITY</p> <p>Location: TAGUITUY, MALINAO ALBAY</p> <p>Sheet Count: AS SHOWN</p>	<p>Scale: 1/8 1/11</p>
	<p>Project No.:</p>	<p>Drawn by:</p>	<p>Checked by:</p>	<p>Reviewed by:</p>	<p>Submitted by:</p>	<p>Approved by:</p>	<p>Project/Contract Name:</p>

Section VIII. Bill of Quantities

Section IX. Checklist of Technical and Financial Documents

Checklist of Technical and Financial Documents

Each Bidder shall submit one (1) Original copy of the first and second component of its Bid. The Procuring entity is requesting an additional three (3) hard copies of the bid.

Sealed Original, Copy 1, Copy 2& 3 in one (1) Single Envelope

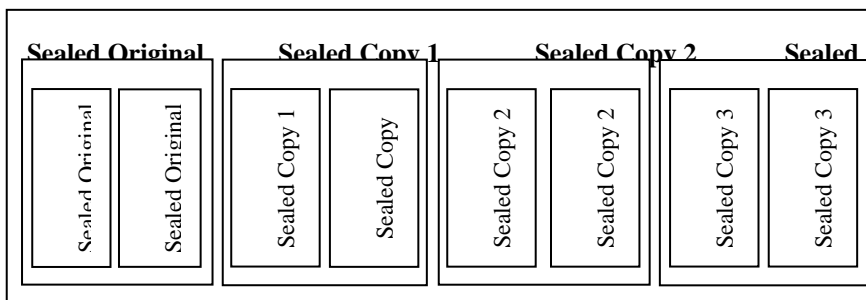

All copies shall be marked Certified True Copy & signed by the bidder or its duly authorized representative.

Additional instructions: All copies must be marked with index/ear tabs or side-end tabs to identify the page components and shall be properly addressed to the **BAC Chairperson**.

I. TECHNICAL COMPONENT ENVELOPE

Class "A" Documents

Legal Documents

- (a) Valid PhilGEPS Registration Certificate (Platinum Membership) (all pages) in accordance with Section 8.5.2 of the IRR;

Technical Documents

- (e) Statement of the prospective bidder of all its ongoing government and private contracts, including contracts awarded but not yet started, if any, whether similar or not similar in nature and complexity to the contract to be bid; **and**
- (f) Statement of the bidder's Single Largest Completed Contract (SLCC) similar to the contract to be bid, except under conditions provided under the rules; **and**
- (g) Special PCAB License in case of Joint Ventures **and** registration for the type and cost of the contract to be bid; **and**
- (h) Original copy of Bid Security. If in the form of a Surety Bond, submit also a certification issued by the Insurance Commission **or** original copy of Notarized Bid Securing Declaration; **and**
- (i) Project Requirements, which shall include the following:
 - a. Organizational chart for the contract to be bid;
 - b. List of contractor's key personnel (e.g., Project Manager, Project Engineers, Materials Engineers, and Foremen), to be assigned to the

- contract to be bid, with their complete qualification and experience data;
- c. List of contractor's major equipment units, which are owned, leased, and/or under purchase agreements, supported by proof of ownership or certification of availability of equipment from the equipment lessor/vendor for the duration of the project, as the case may be; **and**
 - (j) Original duly signed Omnibus Sworn Statement (OSS) **and** if applicable, Original Notarized Secretary's Certificate in case of a corporation, partnership, or cooperative; or Original Special Power of Attorney of all members of the joint venture giving full power and authority to its officer to sign the OSS and do acts to represent the Bidder.

Financial Documents

- (k) The prospective bidder's computation of Net Financial Contracting Capacity (NFCC).

Class "B" Documents

- (l) If applicable, duly signed joint venture agreement (JVA) in accordance with RA No. 4566 and its IRR in case the joint venture is already in existence **or** duly notarized statements from all the potential joint venture partners stating that they will enter into and abide by the provisions of the JVA in the instance that the bid is successful.

II. FINANCIAL COMPONENT ENVELOPE

- (m) Original of duly signed and accomplished Financial Bid Form; **and**

Other documentary requirements under RA No. 9184

- (n) Original of duly signed Bid Prices in the Bill of Quantities; **and**
- (o) Duly accomplished Detailed Estimates Form, including a summary sheet indicating the unit prices of construction materials, labor rates, and equipment rentals used in coming up with the Bid; **and**
- (p) Cash Flow by Quarter.

Section X. Bidding Forms

BID FORM

Date : _____
Project Identification No. : _____

To: *[name and address of Procuring Entity]*

Having examined the Philippine Bidding Documents (PBDs) including the Supplemental or Bid Bulletin Numbers *[insert numbers]*, the receipt of which is hereby duly acknowledged, we, the undersigned, declare that:

- a. We have no reservation to the PBDs, including the Supplemental or Bid Bulletins, for the Procurement Project: *[insert name of contract]*;
- b. We offer to execute the Works for this Contract in accordance with the PBDs;
- c. The total price of our Bid in words and figures, excluding any discounts offered below is: *[insert information]*;
- d. The discounts offered and the methodology for their application are: *[insert information]*;
- e. The total bid price includes the cost of all taxes, such as, but not limited to: *[specify the applicable taxes, e.g. (i) value added tax (VAT), (ii) income tax, (iii) local taxes, and (iv) other fiscal levies and duties]*, which are itemized herein and reflected in the detailed estimates,
- f. Our Bid shall be valid within the a period stated in the PBDs, and it shall remain binding upon us at any time before the expiration of that period;
- g. If our Bid is accepted, we commit to obtain a Performance Security in the amount of *[insert percentage amount]* percent of the Contract Price for the due performance of the Contract, or a Performance Securing Declaration in lieu of the the allowable forms of Performance Security, subject to the terms and conditions of issued GPPB guidelines¹ for this purpose;
- h. We are not participating, as Bidders, in more than one Bid in this bidding process, other than alternative offers in accordance with the Bidding Documents;
- i. We understand that this Bid, together with your written acceptance thereof included in your notification of award, shall constitute a binding contract between us, until a formal Contract is prepared and executed; and
- j. We understand that you are not bound to accept the Lowest Calculated Bid or any other Bid that you may receive.
- k. We likewise certify/confirm that the undersigned, is the duly authorized representative of the bidder, and granted full power and authority to do, execute and perform any and all acts necessary to participate, submit the bid, and to sign and execute the ensuing contract for the [Name of Project] of the [Name of the Procuring Entity].
- l. We acknowledge that failure to sign each and every page of this Bid Form, including the Bill of Quantities, shall be a ground for the rejection of our bid.

Name: _____
Legal Capacity: _____
Signature: _____
Duly authorized to sign the Bid for and behalf of: _____
Date: _____

Bid Securing Declaration Form
[shall be submitted with the Bid if bidder opts to provide this form of bid security]

REPUBLIC OF THE PHILIPPINES)
CITY OF _____) S.S.

BID SECURING DECLARATION
Project Identification No.: *[Insert number]*

To: *[Insert name and address of the Procuring Entity]*

I/We, the undersigned, declare that:

1. I/We understand that, according to your conditions, bids must be supported by a Bid Security, which may be in the form of a Bid Securing Declaration.
2. I/We accept that: (a) I/we will be automatically disqualified from bidding for any procurement contract with any procuring entity for a period of two (2) years upon receipt of your Blacklisting Order; and, (b) I/we will pay the applicable fine provided under Section 6 of the Guidelines on the Use of Bid Securing Declaration, within fifteen (15) days from receipt of the written demand by the procuring entity for the commission of acts resulting to the enforcement of the bid securing declaration under Sections 23.1(b), 34.2, 40.1 and 69.1, except 69.1(f), of the IRR of RA No. 9184; without prejudice to other legal action the government may undertake.
3. I/We understand that this Bid Securing Declaration shall cease to be valid on the following circumstances:
 - a. Upon expiration of the bid validity period, or any extension thereof pursuant to your request;
 - b. I am/we are declared ineligible or post-disqualified upon receipt of your notice to such effect, and (i) I/we failed to timely file a request for reconsideration or (ii) I/we filed a waiver to avail of said right; and
 - c. I am/we are declared the bidder with the Lowest Calculated Responsive Bid, and I/we have furnished the performance security and signed the Contract.

IN WITNESS WHEREOF, I/We have hereunto set my/our hand/s this ____ day of *[month]* *[year]* at *[place of execution]*.

[Insert NAME OF BIDDER OR ITS AUTHORIZED REPRESENTATIVE]
[Insert signatory's legal capacity]
Affiant

[Jurat]
[Format shall be based on the latest Rules on Notarial Practice]

GPPB Resolution No. 16-2020, dated 16 September 2020

Omnibus Sworn Statement (Revised)
[shall be submitted with the Bid]

REPUBLIC OF THE PHILIPPINES)
CITY/MUNICIPALITY OF _____) S.S.

AFFIDAVIT

I, [Name of Affiant], of legal age, [Civil Status], [Nationality], and residing at [Address of Affiant], after having been duly sworn in accordance with law, do hereby depose and state that:

1. *[Select one, delete the other:]*

[If a sole proprietorship:] I am the sole proprietor or authorized representative of [Name of Bidder] with office address at [address of Bidder];

[If a partnership, corporation, cooperative, or joint venture:] I am the duly authorized and designated representative of [Name of Bidder] with office address at [address of Bidder];

2. *[Select one, delete the other:]*

[If a sole proprietorship:] As the owner and sole proprietor, or authorized representative of [Name of Bidder], I have full power and authority to do, execute and perform any and all acts necessary to participate, submit the bid, and to sign and execute the ensuing contract for [Name of the Project] of the [Name of the Procuring Entity], as shown in the attached duly notarized Special Power of Attorney;

[If a partnership, corporation, cooperative, or joint venture:] I am granted full power and authority to do, execute and perform any and all acts necessary to participate, submit the bid, and to sign and execute the ensuing contract for [Name of the Project] of the [Name of the Procuring Entity], as shown in the attached [state title of attached document showing proof of authorization (e.g., duly notarized Secretary's Certificate, Board/Partnership Resolution, or Special Power of Attorney, whichever is applicable)];

3. [Name of Bidder] is not "blacklisted" or barred from bidding by the Government of the Philippines or any of its agencies, offices, corporations, or Local Government Units, foreign government/foreign or international financing institution whose blacklisting rules have been recognized by the Government Procurement Policy Board, **by itself or by relation, membership, association, affiliation, or controlling interest with another blacklisted person or entity as defined and provided for in the Uniform Guidelines on Blacklisting;**

4. Each of the documents submitted in satisfaction of the bidding requirements is an authentic copy of the original, complete, and all statements and information provided therein are true and correct;

5. [Name of Bidder] is authorizing the Head of the Procuring Entity or its duly authorized representative(s) to verify all the documents submitted;

6. *[Select one, delete the rest:]*

[If a sole proprietorship:] The owner or sole proprietor is not related to the Head of the Procuring Entity, members of the Bids and Awards Committee (BAC), the Technical

Working Group, and the BAC Secretariat, the head of the Project Management Office or the end-user unit, and the project consultants by consanguinity or affinity up to the third civil degree;

[If a partnership or cooperative:] None of the officers and members of *[Name of Bidder]* is related to the Head of the Procuring Entity, members of the Bids and Awards Committee (BAC), the Technical Working Group, and the BAC Secretariat, the head of the Project Management Office or the end-user unit, and the project consultants by consanguinity or affinity up to the third civil degree;

[If a corporation or joint venture:] None of the officers, directors, and controlling stockholders of *[Name of Bidder]* is related to the Head of the Procuring Entity, members of the Bids and Awards Committee (BAC), the Technical Working Group, and the BAC Secretariat, the head of the Project Management Office or the end-user unit, and the project consultants by consanguinity or affinity up to the third civil degree;

7. *[Name of Bidder]* complies with existing labor laws and standards; and

8. *[Name of Bidder]* is aware of and has undertaken the responsibilities as a Bidder in compliance with the Philippine Bidding Documents, which includes:

- a. Carefully examining all of the Bidding Documents;
- b. Acknowledging all conditions, local or otherwise, affecting the implementation of the Contract;
- c. Making an estimate of the facilities available and needed for the contract to be bid, if any; and
- d. Inquiring or securing Supplemental/Bid Bulletin(s) issued for the *[Name of the Project]*.

9. *[Name of Bidder]* did not give or pay directly or indirectly, any commission, amount, fee, or any form of consideration, pecuniary or otherwise, to any person or official, personnel or representative of the government in relation to any procurement project or activity.

10. In case advance payment was made or given, failure to perform or deliver any of the obligations and undertakings in the contract shall be sufficient grounds to constitute criminal liability for Swindling (Estafa) or the commission of fraud with unfaithfulness or abuse of confidence through misappropriating or converting any payment received by a person or entity under an obligation involving the duty to deliver certain goods or services, to the prejudice of the public and the government of the Philippines pursuant to Article 315 of Act No. 3815 s. 1930, as amended, or the Revised Penal Code.

IN WITNESS WHEREOF, I have hereunto set my hand this ___ day of ___, 20__ at _____, Philippines.

[Insert NAME OF BIDDER OR ITS AUTHORIZED REPRESENTATIVE]

[Insert signatory's legal capacity]

Affiant

[Jurat]

[Format shall be based on the latest Rules on Notarial Practice]

GPPB Resolution No. 16-2020, dated 16 September 2020

