



Republic of the Philippines  
**DEPARTMENT OF AGRICULTURE**  
Regional Field Office No. 5  
San Agustin, Pili, Camarines Sur 4418

**Supply, Delivery and Installation of Thirteen (13) units Rainshelter  
in Bicol Region for implementation under NUPAP 2025 (per lot  
basis)**

**2025-NUPAP-04**

***ABC: Php 2,600,000.00***

**Sixth Edition**

**January 22, 2025**

# Table of Contents

<b>Glossary of Acronyms, Terms, and Abbreviations .....</b>	<b>3</b>
<b>Section I. Invitation to Bid.....</b>	<b>6</b>
<b>Section II. Instructions to Bidders.....</b>	<b>9</b>
1. Scope of Bid .....	11
2. Funding Information.....	11
3. Bidding Requirements .....	11
4. Corrupt, Fraudulent, Collusive, and Coercive Practices	11
5. Eligible Bidders.....	11
6. Origin of Goods .....	12
7. Subcontracts .....	12
8. Pre-Bid Conference .....	12
9. Clarification and Amendment of Bidding Documents .....	12
10. Documents comprising the Bid: Eligibility and Technical Components .....	12
11. Documents comprising the Bid: Financial Component .....	13
12. Bid Prices .....	13
13. Bid and Payment Currencies .....	13
14. Bid Security .....	14
15. Sealing and Marking of Bids .....	14
16. Deadline for Submission of Bids .....	15
17. Opening and Preliminary Examination of Bids .....	15
18. Domestic Preference .....	15
19. Detailed Evaluation and Comparison of Bids .....	15
20. Post-Qualification .....	16
21. Signing of the Contract .....	16
<b>Section III. Bid Data Sheet .....</b>	<b>17</b>
<b>Section IV. General Conditions of Contract.....</b>	<b>20</b>
1. Scope of Contract .....	21
2. Advance Payment and Terms of Payment .....	21
3. Performance Security .....	21
4. Inspection and Tests .....	22
5. Warranty .....	22
6. Liability of the Supplier .....	22
<b>Section V. Special Conditions of Contract .....</b>	<b>23</b>
<b>Section VI. Schedule of Requirements .....</b>	<b>27</b>
<b>Section VII. Technical Specifications .....</b>	<b>28</b>
<b>Section VIII. Checklist of Technical and Financial Documents .....</b>	<b>33</b>

# ***Glossary of Acronyms, Terms, and Abbreviations***

**ABC** – Approved Budget for the Contract.

**BAC** – Bids and Awards Committee.

**Bid** – A signed offer or proposal to undertake a contract submitted by a bidder in response to and in consonance with the requirements of the bidding documents. Also referred to as *Proposal* and *Tender*. (2016 revised IRR, Section 5[c])

**Bidder** – Refers to a contractor, manufacturer, supplier, distributor and/or consultant who submits a bid in response to the requirements of the Bidding Documents. (2016 revised IRR, Section 5[d])

**Bidding Documents** – The documents issued by the Procuring Entity as the bases for bids, furnishing all information necessary for a prospective bidder to prepare a bid for the Goods, Infrastructure Projects, and/or Consulting Services required by the Procuring Entity. (2016 revised IRR, Section 5[e])

**BIR** – Bureau of Internal Revenue.

**BSP** – Bangko Sentral ng Pilipinas.

**Consulting Services** – Refer to services for Infrastructure Projects and other types of projects or activities of the GOP requiring adequate external technical and professional expertise that are beyond the capability and/or capacity of the GOP to undertake such as, but not limited to: (i) advisory and review services; (ii) pre-investment or feasibility studies; (iii) design; (iv) construction supervision; (v) management and related services; and (vi) other technical services or special studies. (2016 revised IRR, Section 5[i])

**CDA** - Cooperative Development Authority.

**Contract** – Refers to the agreement entered into between the Procuring Entity and the Supplier or Manufacturer or Distributor or Service Provider for procurement of Goods and Services; Contractor for Procurement of Infrastructure Projects; or Consultant or Consulting Firm for Procurement of Consulting Services; as the case may be, as recorded in the Contract Form signed by the parties, including all attachments and appendices thereto and all documents incorporated by reference therein.

**CIF** – Cost Insurance and Freight.

**CIP** – Carriage and Insurance Paid.

**CPI** – Consumer Price Index.

**DDP** – Refers to the quoted price of the Goods, which means “delivered duty paid.”

**DTI** – Department of Trade and Industry.

**EXW** – Ex works.

**FCA** – “Free Carrier” shipping point.

**FOB** – “Free on Board” shipping point.

**Foreign-funded Procurement or Foreign-Assisted Project**–Refers to procurement whose funding source is from a foreign government, foreign or international financing institution as specified in the Treaty or International or Executive Agreement. (2016 revised IRR, Section 5[b]).

**Framework Agreement** – Refers to a written agreement between a procuring entity and a supplier or service provider that identifies the terms and conditions, under which specific purchases, otherwise known as “Call-Offs,” are made for the duration of the agreement. It is in the nature of an option contract between the procuring entity and the bidder(s) granting the procuring entity the option to either place an order for any of the goods or services identified in the Framework Agreement List or not buy at all, within a minimum period of one (1) year to a maximum period of three (3) years. (GPPB Resolution No. 27-2019)

**GFI** – Government Financial Institution.

**GOCC** –Government-owned and/or –controlled corporation.

**Goods** – Refer to all items, supplies, materials and general support services, except Consulting Services and Infrastructure Projects, which may be needed in the transaction of public businesses or in the pursuit of any government undertaking, project or activity, whether in the nature of equipment, furniture, stationery, materials for construction, or personal property of any kind, including non-personal or contractual services such as the repair and maintenance of equipment and furniture, as well as trucking, hauling, janitorial, security, and related or analogous services, as well as procurement of materials and supplies provided by the Procuring Entity for such services. The term “related” or “analogous services” shall include, but is not limited to, lease or purchase of office space, media advertisements, health maintenance services, and other services essential to the operation of the Procuring Entity. (2016 revised IRR, Section 5[r])

**GOP** – Government of the Philippines.

**GPPB** – Government Procurement Policy Board.

**INCOTERMS** – International Commercial Terms.

**Infrastructure Projects** – Include the construction, improvement, rehabilitation, demolition, repair, restoration or maintenance of roads and bridges, railways, airports, seaports, communication facilities, civil works components of information technology projects, irrigation, flood control and drainage, water supply, sanitation, sewerage and solid waste management systems, shore protection, energy/power and electrification facilities, national buildings, school buildings, hospital buildings, and other related construction projects of the government. Also referred to as *civil works or works*. (2016 revised IRR, Section 5[u])

**LGUs** – Local Government Units.

**NFCC** – Net Financial Contracting Capacity.

**NGA** – National Government Agency.

**PhilGEPS** - Philippine Government Electronic Procurement System.

**Procurement Project** – refers to a specific or identified procurement covering goods, infrastructure project or consulting services. A Procurement Project shall be described, detailed, and scheduled in the Project Procurement Management Plan prepared by the agency which shall be consolidated in the procuring entity's Annual Procurement Plan. (GPPB Circular No. 06-2019 dated 17 July 2019)

**PSA** – Philippine Statistics Authority.

**SEC** – Securities and Exchange Commission.

**SLCC** – Single Largest Completed Contract.

**Supplier** – refers to a citizen, or any corporate body or commercial company duly organized and registered under the laws where it is established, habitually established in business and engaged in the manufacture or sale of the merchandise or performance of the general services covered by his bid. (Item 3.8 of GPPB Resolution No. 13-2019, dated 23 May 2019). Supplier as used in these Bidding Documents may likewise refer to a distributor, manufacturer, contractor, or consultant.

**UN** – United Nations.

## ***Section I. Invitation to Bid***



## INVITATION TO BID

### Supply, Delivery and Installation of Thirteen (13) units Rainshelter in Bicol Region for implementation under NUPAP 2025 (Per lot basis)

1. The **Department of Agriculture Regional Field Office No. 5**, through the General Appropriations Act (GAA) for **2025- NUPAP** intends to apply the sum of **Two Million Six Hundred Thousand Pesos (Php2,600,000.00)** being the ABC to payments under the contract for **ITB No. 2025-NUPAP-04**.

Bids received in excess of the ABC shall be automatically rejected at bid opening. **Partial bid is ALLOWED.**

2. The **Department of Agriculture Regional Field Office No. 5** now invites bids for the following:

Description	Location of Project	Specifications	Unit Price	Total Price	Delivery of the Goods
<b>LOT 1</b>					
6 units	Albay	Rain shelter  *Should conform to Detailed Engineering Design and Bill of Quantities Proposal (BOQ)  *Specifications and Method of Construction should conform with the applicable provisions stated in PNS PAES 415:2001 Greenhouses	200,000.00	1,200,000.00	90 cd upon receipt of NTP
<b>LOT 2</b>					
3 units	Camarines Sur	Rain shelter  *Should conform to Detailed Engineering Design and Bill of Quantities Proposal (BOQ)  *Specifications and Method of Construction should conform with the applicable provisions stated in PNS PAES 415:2001 Greenhouses	200,000.00	600,000.00	90 cd upon receipt of NTP
<b>LOT 3</b>					
1 unit	Camarines Norte	Rain shelter  *Should conform to Detailed Engineering Design and Bill of Quantities Proposal (BOQ)	200,000.00	200,000.00	90 cd upon receipt of NTP

		*Specifications and Method of Construction should conform with the applicable provisions stated in PNS PAES 415:2001 Greenhouses			
LOT 4					
3 units	Sorsogon	Rain shelter  *Should conform to Detailed Engineering Design and Bill of Quantities Proposal (BOQ)  *Specifications and Method of Construction should conform with the applicable provisions stated in PNS PAES 415:2001 Greenhouses	200,000.00	600,000.00	90 cd upon receipt of NTP

Bidders should have completed, within **Two (2) years** from the date of submission and receipt of bids, a contract similar to the Project. The description of an eligible bidder is contained in the Bidding Documents, particularly, in Section II (Instructions to Bidders).

- Bidding will be conducted through open competitive bidding procedures using a non-discretionary “*pass/fail*” criterion as specified in the 2016 revised Implementing Rules and Regulations (IRR) of Republic Act (RA) No. 9184.

Bidding is restricted to Filipino citizens/sole proprietorships, partnerships, or organizations with at least sixty percent (60%) interest or outstanding capital stock belonging to citizens of the Philippines, and to citizens or organizations of a country the laws or regulations of which grant similar rights or privileges to Filipino citizens, pursuant to RA No. 5183.

- Prospective Bidders may obtain further information from **Department of Agriculture Regional Field Office No. 5** and inspect the Bidding Documents at the address given below during **Mondays – Fridays, 8:00 AM to 5:00 PM except for Holidays, Saturdays and Sundays**.
- A complete set of Bidding Documents may be acquired by interested Bidders on **January 24, 2025 – February 17, 2024 (1:00 PM)** from the given address and website(s) below and upon payment of the applicable fee for the Bidding Documents, pursuant to the latest Guidelines issued by the GPPB. The cost of the bidding document shall be on per lot basis. Should the prospective bidder participate in two (2) or more items, the cost of the bidding documents shall be based on the sum of the ABCs of the items to be bid:

DESCRIPTION	AMOUNT (in PhP)	Cost/Price of Bid Documents (cash payment only) (Php)
Lot 1 – 6 units Rainshelter	1,200,000.00	5,000.00
Lot 2 – 3 units Rainshelter	600,000.00	1,000.00
Lot 3 – 1 unit Rainshelter	200,000.00	500.00
Lot 4 –3 units Rainshelter	600,000.00	1,000.00
<b>Total</b>	<b>2,600,000</b>	P5,000.00 (all lots)



The Procuring Entity shall allow the bidder to present its proof of payment for the fees.

6. The **DA RFO 5** will hold a **Pre-Bid Conference on February 3, 2025; 1:30 PM** at 3<sup>rd</sup> Flr. Training Hall, Operations Bldg., DA RFO-5, San Agustin, Pili, Camarines Sur, which shall be open to prospective bidders.
7. Bids must be duly received by the BAC Secretariat through manual submission at the office address indicated below, on or before **February 17, 2025; 1:00 PM**. **LATE BIDS SHALL NOT BE ACCEPTED.**
8. All Bids must be accompanied by a bid security in any of the acceptable forms and in the amount stated in **ITB** Clause 14.
9. **Bid opening shall be on February 17, 2025; 1:30 PM** at the given address below 3<sup>rd</sup> Flr. Training Hall, Operations Bldg., DA RFO-5, San Agustin, Pili, Camarines Sur and/or through teleconferencing/webcasting via *ZOOM*. Bids will be opened in the presence of the bidders' representatives who choose to attend the activity.
10. In case of a tie Bid, the BAC will conduct the Guidelines on the Use of Non-Discretionary/Non-Discriminatory Selection criteria as Tie-Breaking Method thru DRAW LOTS in case of two or more Bidders have been post-qualified determined as the bidder having the Lowest calculated and Responsive Bidder (LCRB) (GPPB Circular No. 06-2005).
11. The **DA RFO 5** reserves the right to reject any and all bids, declare a failure of bidding, or not award the contract at any time prior to contract award in accordance with Sections 35.6 and 41 of the 2016 revised IRR of RA No. 9184, without thereby incurring any liability to the affected bidder or bidders.
12. For further information, please refer to:

BAC Secretariat Office

**Department of Agriculture, Regional Field Office No. 5**

San Agustin, Pili, Camarines Sur 4418

Email Address: [bacrfo5@gmail.com](mailto:bacrfo5@gmail.com)

You may visit the following websites:

For Downloading of Bidding Documents: [bicol.da.gov.ph](http://bicol.da.gov.ph) .

**January 22, 2025**, San Agustin, Pili, Camarines Sur

**LORENZO L. ALVINA**

OIC, RTD for Research and Regulations  
Chairperson, Bids and Awards Committee

## ***Section II. Instructions to Bidders***

## 1. Scope of Bid

The Procuring Entity, *Department of Agriculture Regional Field Office No. 5* wishes to receive Bids for **Supply, Delivery and Installation of Thirteen (13) units Rainshelter in Bicol Region for implementation under NUPAP 2025** with identification number **2025-NUPAP-04**.

The Procurement Project (referred to herein as “Project”) is composed of **Four (4) Lots**, the details of which are described in Section VII (Technical Specifications).

## 2. Funding Information

2.1. The GOP through the source of funding as indicated below **General Appropriations Act (GAA) for 2025- NUPAP** in the amount of **Two Million Six Hundred Thousand Pesos (Php2,600,000.00)**.

- a. NGA, the General Appropriations Act or Special Appropriations

## 3. Bidding Requirements

The Bidding for the Project shall be governed by all the provisions of RA No. 9184 and its 2016 revised IRR, including its Generic Procurement Manuals and associated policies, rules and regulations as the primary source thereof, while the herein clauses shall serve as the secondary source thereof.

Any amendments made to the IRR and other GPPB issuances shall be applicable only to the ongoing posting, advertisement, or **IB** by the BAC through the issuance of a supplemental or bid bulletin.

The Bidder, by the act of submitting its Bid, shall be deemed to have verified and accepted the general requirements of this Project, including other factors that may affect the cost, duration and execution or implementation of the contract, project, or work and examine all instructions, forms, terms, and project requirements in the Bidding Documents.

## 4. Corrupt, Fraudulent, Collusive, and Coercive Practices

The Procuring Entity, as well as the Bidders and Suppliers, shall observe the highest standard of ethics during the procurement and execution of the contract. They or through an agent shall not engage in corrupt, fraudulent, collusive, coercive, and obstructive practices defined under Annex “I” of the 2016 revised IRR of RA No. 9184 or other integrity violations in competing for the Project.

## 5. Eligible Bidders

- 5.1. Only Bids of Bidders found to be legally, technically, and financially capable will be evaluated.
- 5.2. Foreign ownership exceeding those allowed under the rules may participate in this Projects (B).

5.3. Pursuant to Section 23.4.1.3 of the 2016 revised IRR of RA No.9184, the Bidder shall have an SLCC that is at least one (1) contract similar to the Project

the value of which, adjusted to current prices using the PSA's CPI, must be at least **fifty percent (50%) of the ABC per lot in the amount of Lot 1 – Php600,000.00, Lot 2 – P300,000.00, Lot 3 – P100,000.00 and Lot 4 – P300,000.00 or (50%) of the total ABC in the amount of P1,300,000.00**

- 5.4. The Bidders shall comply with the eligibility criteria under Section 23.4.1 of the 2016 IRR of RA No. 9184.

## 6. Origin of Goods

There is no restriction on the origin of goods other than those prohibited by a decision of the UN Security Council taken under Chapter VII of the Charter of the UN, subject to Domestic Preference requirements under **ITB** Clause 18.

## 7. Subcontracts

- 7.1. The Bidder may subcontract portions of the Project to the extent allowed by the Procuring Entity as stated herein, but in no case more than twenty percent (20%) of the Project.

The Procuring Entity has prescribed that:

- a. Subcontracting is not allowed.

## 8. Pre-Bid Conference

The Procuring Entity will hold a pre-bid conference for this Project on the specified date and time and either at its physical address at **DA RFO 5, San Agustin, Pili, Camarines Sur** and/or through videoconferencing/webcasting} as indicated in paragraph 6 of the **IB**.

## 9. Clarification and Amendment of Bidding Documents

Prospective bidders may request for clarification on and/or interpretation of any part of the Bidding Documents. Such requests must be in writing and received by the Procuring Entity, either at its given address or through electronic mail indicated in the **IB**, at least ten (10) calendar days before the deadline set for the submission and receipt of Bids.

## 10. Documents comprising the Bid: Eligibility and Technical Components

- 10.1. The first envelope shall contain the eligibility and technical documents of the Bid as specified in **Section VIII (Checklist of Technical and Financial Documents)**.
- 10.2. The Bidder's SLCC as indicated in **ITB** Clause 5.3 should have been completed within **TWO (2) YEARS** prior to the deadline for the submission and receipt of bids.
- 10.3. If the eligibility requirements or statements, the bids, and all other documents for submission to the BAC are in foreign language other than English, it must be accompanied by a translation in English, which shall be authenticated by the appropriate Philippine foreign service establishment, post, or the equivalent office having jurisdiction over the foreign bidder's affairs in the Philippines. Similar to

the required authentication above, for Contracting Parties to the Apostille Convention, only the translated documents shall be authenticated through an apostille pursuant to GPPB Resolution No. 13-2019 dated 23 May 2019. The English translation shall govern, for purposes of interpretation of the bid.

## 11. Documents comprising the Bid: Financial Component

- 11.1. The second bid envelope shall contain the financial documents for the Bid as specified in **Section VIII (Checklist of Technical and Financial Documents)**.
- 11.2. If the Bidder claims preference as a Domestic Bidder or Domestic Entity, a certification issued by DTI shall be provided by the Bidder in accordance with Section 43.1.3 of the 2016 revised IRR of RA No. 9184.
- 11.3. Any bid exceeding the ABC indicated in paragraph 1 of the **IB** shall not be accepted.
- 11.4. For Foreign-funded Procurement, a ceiling may be applied to bid prices provided the conditions are met under Section 31.2 of the 2016 revised IRR of RA No. 9184.

## 12. Bid Prices

- 12.1. Prices indicated on the Price Schedule shall be entered separately in the following manner:
  - a. For Goods offered from within the Procuring Entity's country:
    - i. The price of the Goods quoted EXW (ex-works, ex-factory, ex-warehouse, ex-showroom, or off-the-shelf, as applicable);
    - ii. The cost of all customs duties and sales and other taxes already paid or payable;
    - iii. The cost of transportation, insurance, and other costs incidental to delivery of the Goods to their final destination; and
    - iv. The price of other (incidental) services, if any, listed in e.
  - b. For Goods offered from abroad:
    - i. Unless otherwise stated in the **BDS**, the price of the Goods shall be quoted delivered duty paid (DDP) with the place of destination in the Philippines as specified in the **BDS**. In quoting the price, the Bidder shall be free to use transportation through carriers registered in any eligible country. Similarly, the Bidder may obtain insurance services from any eligible source country.
    - ii. The price of other (incidental) services, if any, as listed in **Section VII (Technical Specifications)**.

## 13. Bid and Payment Currencies

- 13.1. For Goods that the Bidder will supply from outside the Philippines, the bid prices may be quoted in the local currency or tradeable currency accepted by the BSP at

the discretion of the Bidder. However, for purposes of bid evaluation, Bids denominated in foreign currencies, shall be converted to Philippine currency based on the exchange rate as published in the BSP reference rate bulletin on the day of the bid opening.

13.2. Payment of the contract price shall be made in:

- a. Philippine Pesos.

## 14. Bid Security

14.1. The Bidder shall submit a Bid Securing Declaration or any form of Bid Security in the amount indicated in the **BDS**, which shall be not less than the percentage of the ABC in accordance with the schedule in the **BDS**.

14.2. **The Bid and bid security shall be valid until June 17, 2025 (120 days)**. Any Bid not accompanied by an acceptable bid security shall be rejected by the Procuring Entity as non-responsive.

## 15. Sealing and Marking of Bids

**Each Bidder shall submit one (1) Original copy of the first and second component of its Bid. The Procuring entity is requesting an additional three (3) hard copies of the bid.** However, failure of the Bidders to comply with the said request shall not be a ground for disqualification.

If the Procuring Entity allows the submission of bids through online submission or any other electronic means, the Bidder shall submit an electronic copy of its Bid, which must be digitally signed. An electronic copy that cannot be opened or is corrupted shall be considered non-responsive and, thus, automatically disqualified.

### **Sealed Original, Copy 1, Copy 2 & 3 in one (1) Single Envelope**

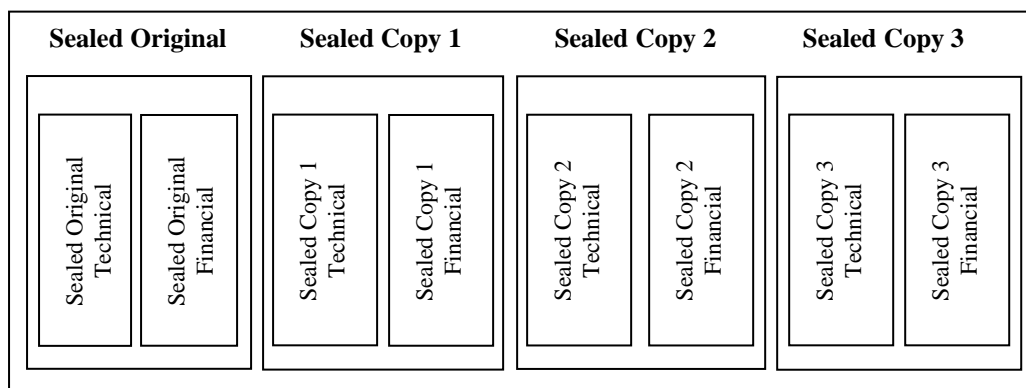

All copies shall be marked Certified True Copy & signed by the bidder or its duly authorized representative.

**Additional instructions:** All copies must be marked with index/ear tabs or side-end tabs to identify the page components and shall be properly addressed to the **BAC Chairperson**.

## 16. Deadline for Submission of Bids

- 16.1. The Bidders shall submit on the specified date and time and either at its physical address or through online submission as indicated in paragraph 7 of the **IB**.

## 17. Opening and Preliminary Examination of Bids

- 17.1. The BAC shall open the Bids in public at the time, on the date, and at the place specified in paragraph 9 of the **IB**. The Bidders' representatives who are present shall sign a register evidencing their attendance. In case videoconferencing, webcasting or other similar technologies will be used, attendance of participants shall likewise be recorded by the BAC Secretariat.

In case the Bids cannot be opened as scheduled due to justifiable reasons, the rescheduling requirements under Section 29 of the 2016 revised IRR of RA No. 9184 shall prevail.

- 17.2. The preliminary examination of bids shall be governed by Section 30 of the 2016 revised IRR of RA No. 9184.

## 18. Domestic Preference

- 18.1. The Procuring Entity will grant a margin of preference for the purpose of comparison of Bids in accordance with Section 43.1.2 of the 2016 revised IRR of RA No. 9184.

## 19. Detailed Evaluation and Comparison of Bids

- 19.1. The Procuring BAC shall immediately conduct a detailed evaluation of all Bids rated "*passed*," using non-discretionary pass/fail criteria. The BAC shall consider the conditions in the evaluation of Bids under Section 32.2 of the 2016 revised IRR of RA No. 9184.
- 19.2. If the Project allows partial bids, bidders may submit a proposal on any of the lots or items, and evaluation will be undertaken on a per lot or item basis, as the case maybe. In this case, the Bid Security as required by **ITB** Clause 15 shall be submitted for each lot or item separately.
- 19.3. The descriptions of the lots or items shall be indicated in **Section VII (Technical Specifications)**, although the ABCs of these lots or items are indicated in the **BDS** for purposes of the NFCC computation pursuant to Section 23.4.2.6 of the 2016 revised IRR of RA No. 9184. The NFCC must be sufficient for the total of the ABCs for all the lots or items participated in by the prospective Bidder.
- 19.4. The Project shall be awarded as **One Project having several items grouped into several lots, which shall be awarded as separate contracts per lot.**
- 19.5. Except for bidders submitting a committed Line of Credit from a Universal or Commercial Bank in lieu of its NFCC computation, all Bids must include the NFCC computation pursuant to Section 23.4.1.4 of the 2016 revised IRR of RA No. 9184, which must be sufficient for the total of the ABCs for all the lots or items participated in by the prospective Bidder. For bidders submitting the committed

Line of Credit, it must be at least equal to ten percent (10%) of the ABCs for all the lots or items participated in by the prospective Bidder.

## **20. Post-Qualification**

- 20.2. Within a non-extendible period of five (5) calendar days from receipt by the Bidder of the notice from the BAC that it submitted the Lowest Calculated Bid, the Bidder shall submit its latest income and business tax returns filed and paid through the BIR Electronic Filing and Payment System (Efps) and other appropriate licenses and permits required by law and stated in the **BDS**.

## **21. Signing of the Contract**

- 21.1. The documents required in Section 37.2 of the 2016 revised IRR of RA No. 9184 shall form part of the Contract. Additional Contract documents are indicated in the **BDS**.



## ***Section III. Bid Data Sheet***

# Bid Data Sheet

ITB Clause																			
5.3	<p>For this purpose, contracts similar to the Project shall be:</p> <ul style="list-style-type: none"> <li>a. <b>Rainshelter/Greenhouse (Lots 1-4)</b></li> <li>b. Completed within <b>Two (2) years</b> prior to the deadline for the submission and receipt of bids.</li> </ul>																		
7.1	No further instruction																		
12	The price of the Goods shall be quoted DDP DA RFO 5, SAN AGUSTIN, PILI, CAMARINES SUR or the applicable International Commercial Terms (INCOTERMS) for this Project.																		
14.1	<p>The bid security shall be in the form of a Bid Securing Declaration, or any of the following forms and amounts:</p> <ul style="list-style-type: none"> <li>a. The amount of not less than <b>Php52,000.00</b>, if bid security is in cash, cashier's/manager's check, bank draft/guarantee or irrevocable letter of credit; or</li> <li>b. The amount of not less than <b>Php130,000.00</b>, if bid security is in Surety Bond.</li> </ul>																		
19.3	<p><b>Partial bid is allowed.</b></p> <table border="1" style="width: 100%; border-collapse: collapse;"> <thead> <tr> <th style="text-align: center;">Qty</th> <th style="text-align: center;">Description</th> <th style="text-align: center;">ABC (Php) (inclusive of VAT)</th> </tr> </thead> <tbody> <tr> <td style="text-align: center;">Lot 1-6units</td> <td>Supply, Delivery and Installation of Rainshelter in Bicol Region</td> <td style="text-align: right;">Php1,200,000.00</td> </tr> <tr> <td style="text-align: center;">Lot 2-3 units</td> <td>Supply, Delivery and Installation of Rainshelter in Bicol Region</td> <td style="text-align: right;">600,000.00</td> </tr> <tr> <td style="text-align: center;">Lot 3-1unit</td> <td>Supply, Delivery and Installation of Rainshelter in Bicol Region</td> <td style="text-align: right;">200,000.00</td> </tr> <tr> <td style="text-align: center;">Lot 4-3 units</td> <td>Supply, Delivery and Installation of Rainshelter in Bicol Region</td> <td style="text-align: right;">600,000.00</td> </tr> <tr> <td colspan="2" style="text-align: right;"><b>TOTAL (LOTS 1-4)</b></td> <td style="text-align: right;"><b>2,600,000.00</b></td> </tr> </tbody> </table>	Qty	Description	ABC (Php) (inclusive of VAT)	Lot 1-6units	Supply, Delivery and Installation of Rainshelter in Bicol Region	Php1,200,000.00	Lot 2-3 units	Supply, Delivery and Installation of Rainshelter in Bicol Region	600,000.00	Lot 3-1unit	Supply, Delivery and Installation of Rainshelter in Bicol Region	200,000.00	Lot 4-3 units	Supply, Delivery and Installation of Rainshelter in Bicol Region	600,000.00	<b>TOTAL (LOTS 1-4)</b>		<b>2,600,000.00</b>
Qty	Description	ABC (Php) (inclusive of VAT)																	
Lot 1-6units	Supply, Delivery and Installation of Rainshelter in Bicol Region	Php1,200,000.00																	
Lot 2-3 units	Supply, Delivery and Installation of Rainshelter in Bicol Region	600,000.00																	
Lot 3-1unit	Supply, Delivery and Installation of Rainshelter in Bicol Region	200,000.00																	
Lot 4-3 units	Supply, Delivery and Installation of Rainshelter in Bicol Region	600,000.00																	
<b>TOTAL (LOTS 1-4)</b>		<b>2,600,000.00</b>																	
20.2	<p>The bidder shall submit:</p> <ul style="list-style-type: none"> <li>a. Certificate of Availability and Location of Stocks</li> <li>b. Certificate of Authority to Supply and to Bid from the Source</li> <li>c. Certification as to dealership or distributorship</li> <li>d. BIR Registration Certificate</li> <li>e. Latest Income Tax Return</li> <li>f. Latest VAT Payment</li> <li>g. Performance Evaluation Report (at least very satisfactory) of Single Largest Completed Contract (SLCC) duly signed by the end-user with the approval of the Director or RTD for Government Contract and with the approval of the highest-ranking official for private contract.</li> <li>h. Attachment of SLCC [Notice of Award, Contract or PO, Notice to Proceed and Inspection and Acceptance (COA Form) (if government), For Private Contract: Contract/PO and Delivery Receipt with Proof of Acceptance]</li> </ul>																		

	i. Other requirements peculiar to the procurement project under consideration
21.2	No further instruction

## ***Section IV. General Conditions of Contract***

## 1. Scope of Contract

This Contract shall include all such items, although not specifically mentioned, that can be reasonably inferred as being required for its completion as if such items were expressly mentioned herein. All the provisions of RA No. 9184 and its 2016 revised IRR, including the Generic Procurement Manual, and associated issuances, constitute the primary source for the terms and conditions of the Contract, and thus, applicable in contract implementation. Herein clauses shall serve as the secondary source for the terms and conditions of the Contract.

This is without prejudice to Sections 74.1 and 74.2 of the 2016 revised IRR of RA No. 9184 allowing the GPPB to amend the IRR, which shall be applied to all procurement activities, the advertisement, posting, or invitation of which were issued after the effectivity of the said amendment.

Additional requirements for the completion of this Contract shall be provided in the **Special Conditions of Contract (SCC)**.

## 2. Advance Payment and Terms of Payment

2.1. Advance payment of the contract amount is provided under Annex "D" of the revised 2016 IRR of RA No. 9184.

2.2. The Procuring Entity is allowed to determine the terms of payment on the partial or staggered delivery of the Goods procured, provided such partial payment shall correspond to the value of the goods delivered and accepted in accordance with prevailing accounting and auditing rules and regulations. The terms of payment are indicated in the **SCC**.

*[Include the following clauses if Framework Agreement will be used:]*

2.3. For a single-year Framework Agreement, prices charged by the Supplier for Goods delivered and/or services performed under a Call-Off shall not vary from the prices quoted by the Supplier in its bid.

2.4. For multi-year Framework Agreement, prices charged by the Supplier for Goods delivered and/or services performed under a Call-Off shall not vary from the prices quoted by the Supplier during conduct of Mini-Competition.

## 3. Performance Security

Within ten (10) calendar days from receipt of the Notice of Award by the Bidder from the Procuring Entity but in no case later than prior to the signing of the Contract by both parties, the successful Bidder shall furnish the performance security in any of the forms prescribed in Section 39 of the 2016 revised IRR of RA No. 9184.

#### **4. Inspection and Tests**

The Procuring Entity or its representative shall have the right to inspect and/or to test the Goods to confirm their conformity to the Project specifications at no extra cost to the Procuring Entity in accordance with the Generic Procurement Manual. In addition to tests in the **SCC, Section IV (Technical Specifications)** shall specify what inspections and/or tests the Procuring Entity requires, and where they are to be conducted. The Procuring Entity shall notify the Supplier in writing, in a timely manner, of the identity of any representatives retained for these purposes.

All reasonable facilities and assistance for the inspection and testing of Goods, including access to drawings and production data, shall be provided by the Supplier to the authorized inspectors at no charge to the Procuring Entity.

#### **5. Warranty**

- 6.1. In order to assure that manufacturing defects shall be corrected by the Supplier, a warranty shall be required from the Supplier as provided under Section 62.1 of the 2016 revised IRR of RA No. 9184.
- 6.2. The Procuring Entity shall promptly notify the Supplier in writing of any claims arising under this warranty. Upon receipt of such notice, the Supplier shall, repair or replace the defective Goods or parts thereof without cost to the Procuring Entity, pursuant to the Generic Procurement Manual.

#### **6. Liability of the Supplier**

The Supplier's liability under this Contract shall be as provided by the laws of the Republic of the Philippines.

If the Supplier is a joint venture, all partners to the joint venture shall be jointly and severally liable to the Procuring Entity.

## ***Section V. Special Conditions of Contract***

# Special Conditions of Contract

GCC Clause	
1	<p><b>Delivery and Documents –</b></p> <p>For purposes of the Contract, “EXW,” “FOB,” “FCA,” “CIF,” “CIP,” “DDP” and other trade terms used to describe the obligations of the parties shall have the meanings assigned to them by the current edition of INCOTERMS published by the International Chamber of Commerce, Paris. The Delivery terms of this Contract shall be as follows:</p> <p>The delivery terms applicable to this Contract are delivered to <b>Albay, Camarines Sur, Camarines Norte and Sorsogon</b>. Risk and title will pass from the Supplier to the Procuring Entity upon receipt and final acceptance of the Goods at their final destination.”</p> <p>Delivery of the Goods shall be made by the Supplier in accordance with the terms specified in Section VI (Schedule of Requirements).</p> <p>For purposes of this Clause the Procuring Entity’s Representative at the Project Site is <b><i>Ms. Cristina E. Borja, Property Officer</i></b></p> <p><b>Incidental Services –</b></p> <p>The Supplier is required to provide all of the following services, including additional services, if any, specified in Section VI. Schedule of Requirements:</p> <ol style="list-style-type: none"> <li>a. performance or supervision of on-site assembly and/or start-up of the supplied Goods;</li> <li>b. furnishing of tools required for assembly and/or maintenance of the supplied Goods;</li> <li>c. furnishing of a detailed operations and maintenance manual for each appropriate unit of the supplied Goods;</li> <li>d. performance or supervision or maintenance and/or repair of the supplied Goods, for a period of time agreed by the parties, provided that this service shall not relieve the Supplier of any warranty obligations under this Contract; and</li> <li>e. training of the Procuring Entity’s personnel, at the Supplier’s plant and/or on-site, in assembly, start-up, operation, maintenance, and/or repair of the supplied Goods.</li> </ol>
	<p>The Contract price for the Goods shall include the prices charged by the Supplier for incidental services and shall not exceed the prevailing rates charged to other parties by the Supplier for similar services.</p>
	<p><b>Spare Parts –</b></p> <p>The Supplier is required to provide all of the following materials, notifications, and information pertaining to spare parts manufactured or distributed by the Supplier:</p>



	<p>a. such spare parts as the Procuring Entity may elect to purchase from the Supplier, provided that this election shall not relieve the Supplier of any warranty obligations under this Contract; and</p> <p>b. in the event of termination of production of the spare parts:</p> <ul style="list-style-type: none"> <li>i. advance notification to the Procuring Entity of the pending termination, in sufficient time to permit the Procuring Entity to procure needed requirements; and</li> <li>ii. following such termination, furnishing at no cost to the Procuring Entity, the blueprints, drawings, and specifications of the spare parts, if requested.</li> </ul> <p>The spare parts and other components required are listed in <b>Section VI (Schedule of Requirements)</b> and the cost thereof are included in the contract price.</p> <p>The Supplier shall carry sufficient inventories to assure ex-stock supply of consumable spare parts or components for the Goods for a period of [<i>indicate here the time period specified. If not used indicate a time period of three times the warranty period</i>].</p> <p>Spare parts or components shall be supplied as promptly as possible, but in any case, within [<i>insert appropriate time period</i>] months of placing the order.</p>
	<p><b>Packaging –</b></p> <p>The Supplier shall provide such packaging of the Goods as is required to prevent their damage or deterioration during transit to their final destination, as indicated in this Contract. The packaging shall be sufficient to withstand, without limitation, rough handling during transit and exposure to extreme temperatures, salt and precipitation during transit, and open storage. Packaging case size and weights shall take into consideration, where appropriate, the remoteness of the Goods’ final destination and the absence of heavy handling facilities at all points in transit.</p> <p>The packaging, marking, and documentation within and outside the packages shall comply strictly with such special requirements as shall be expressly provided for in the Contract, including additional requirements,</p>
	<p>if any, specified below, and in any subsequent instructions ordered by the Procuring Entity.</p> <p>The outer packaging must be clearly marked on at least four (4) sides as follows:</p> <p>Name of the Procuring Entity  Name of the Supplier  Contract Description  Final Destination</p>

	<p>Gross weight Any special lifting instructions Any special handling instructions Any relevant HAZCHEM classifications</p>
	<p>A packaging list identifying the contents and quantities of the package is to be placed on an accessible point of the outer packaging if practical. If not practical the packaging list is to be placed inside the outer packaging but outside the secondary packaging.</p> <p><b>Transportation –</b></p> <p>Where the Supplier is required under Contract to deliver the Goods CIF, CIP, or DDP, transport of the Goods to the port of destination or such other named place of destination in the Philippines, as shall be specified in this Contract, shall be arranged and paid for by the Supplier, and the cost thereof shall be included in the Contract Price.</p> <p>Where the Supplier is required under this Contract to transport the Goods to a specified place of destination within the Philippines, defined as the Project Site, transport to such place of destination in the Philippines, including insurance and storage, as shall be specified in this Contract, shall be arranged by the Supplier, and related costs shall be included in the contract price.</p>
	<p>Where the Supplier is required under Contract to deliver the Goods CIF, CIP or DDP, Goods are to be transported on carriers of Philippine registry. In the event that no carrier of Philippine registry is available, Goods may be shipped by a carrier which is not of Philippine registry provided that the Supplier obtains and presents to the Procuring Entity certification to this effect from the nearest Philippine consulate to the port of dispatch. In the event that carriers of Philippine registry are available but their schedule delays the Supplier in its performance of this Contract the period from when the Goods were first ready for shipment and the actual date of shipment the period of delay will be considered force majeure.</p> <p>The Procuring Entity accepts no liability for the damage of Goods during transit other than those prescribed by INCOTERMS for DDP deliveries. In the case of Goods supplied from within the Philippines or supplied by domestic Suppliers risk and title will not be deemed to have passed to the</p>
	<p>Procuring Entity until their receipt and final acceptance at the final destination.</p> <p><b>Intellectual Property Rights –</b></p> <p>The Supplier shall indemnify the Procuring Entity against all third-party claims of infringement of patent, trademark, or industrial design rights arising from use of the Goods or any part thereof.</p>
2.2	The terms of payment shall be in <b>full payment</b> after completion of the delivery duly inspected by the inspector and by Focal Person or its representative.
4	The inspections that will be conducted are based on the minimum specifications required as indicated in the Technical Specifications.

## ***Section VI. Schedule of Requirements***

The delivery schedule expressed as weeks/months stipulates hereafter a delivery date which is the date of delivery to the project site.

<b>LOT NO.</b>	<b>Description</b>	<b>Quantity</b>	<b>Total</b>	<b>Delivered, Weeks/Months</b>
<b>1</b>	Supply, Delivery and Installation of Rainshelter in Bicol Region	6 units	Php1,200,000.00	90 cd upon receipt of NTP
<b>2</b>	Supply, Delivery and Installation of Rainshelter in Bicol Region	3 units	600,000.00	90 cd upon receipt of NTP
<b>3</b>	Supply, Delivery and Installation of Rainshelter in Bicol Region	1 unit	200,000.00	90 cd upon receipt of NTP
<b>4</b>	Supply, Delivery and Installation of Rainshelter in Bicol Region	3 units	600,000.00	90 cd upon receipt of NTP

**DELIVERY SITE:**

- 6 units – Albay
- 3 units – Camarines Sur
- 1 unit – Camarines Norte
- 3 units – Sorsogon

I hereby commit to comply and deliver all the above requirements in accordance with above stated schedule.

Signature over Printed Name of Authorized Representative

\_\_\_\_\_

Date: \_\_\_\_\_

## ***Section VII. Technical Specifications***

## Technical Specifications

Item	Specification	Statement of Compliance
		<p><i>[Bidders must state here either "Comply" or "Not Comply" against each of the individual parameters of each Specification stating the corresponding performance parameter of the equipment offered. Statements of "Comply" or "Not Comply" must be supported by evidence in a Bidders Bid and cross-referenced to that evidence. Evidence shall be in the form of manufacturer's un-amended sales literature, unconditional statements of specification and compliance issued by the manufacturer, samples, independent test data etc., as appropriate. A statement that is not supported by evidence or is subsequently found to be contradicted by the evidence presented will render the Bid under evaluation liable for rejection. A statement either in the Bidder's statement of compliance or the supporting evidence that is found to be false either during Bid evaluation, post-qualification or the execution of the Contract may be regarded as fraudulent and render the Bidder or supplier liable for prosecution subject to the applicable laws and issuances.]</i></p>
1	Supply, Delivery and Installation of 6 <b>units Rainshelter</b> in Bicol Region	
2	Supply, Delivery and Installation of 3 <b>units Rainshelter</b> in Bicol Region	
3	Supply, Delivery and Installation of 1 <b>unit Rainshelter</b> in Bicol Region	
4	Supply, Delivery and Installation of 3 <b>units Rainshelter</b> in Bicol Region	
<ul style="list-style-type: none"> <li>a. Certificate of Availability and Location of Stocks</li> <li>b. Certificate of Authority to Supply and to Bid from the Source</li> <li>c. Certification as to dealership or distributorship</li> </ul>		

\*Bidder/s may attach the above-mentioned documents but not be a ground for disqualification during the bid opening



Department of Agriculture  
**Regional Field Office No. 5**  
San Agustin, Pili, Camarines Sur

**BILL OF QUANTITIES AND COST PROPOSAL**  
(AGRI INFRA & OTHER INFRASTRUCTURE)

<b>NAME/LOCATION OF PROJECT:</b>		Appropriation (Php)		<b>₱ 200,000.00</b>		
<b>SUPPLY, DELIVERY AND INSTALLATION OF 13-UNITS RAIN SHELTER</b>		Source of Funds		NUPAP T1 2025		
		Issued Obligated Authority				
<b>Location:</b> BICOL REGION		Mode of Implementation		By Contract		
		Released				
<b>PROJECT CATEGORY:</b> AGRI-INFRASTRUCTURE		Calendar Days to Complete		10 CD		
		Starting Date				
<b>PROJECT DESCRIPTION:</b> <i>Installation of 13-units Rain Shelter (4m x 12m)</i> <i>Installation of water sprinklers and 1/2 HP water pump</i>						
<b>Description</b>	<b>No.</b>	<b>Description</b>	<b>No.</b>	<b>Description</b>	<b>No.</b>	
Minor Tools				<b>TECHNICAL PERSONNEL REQUIRED</b>		
Angle Grinder				<b>Description</b>	<b>No.</b>	
Welding Machine						
Pipe Bender				Skilled Laborer	2 to 4	
				Unskilled Laborer	1 to 3	
<b>Item</b>		<b>Description</b>	<b>Unit</b>	<b>Quantity</b>	<b>Unit Cost (PhP)</b>	<b>Total Amount (PhP)</b>
B.9		OTHER GENERAL REQUIREMENTS	lot	1.00		
103, 104		EARTHWORKS				
		<i>Excavation</i>	cu.m	0.82		
		<i>Backfill</i>	cu.m	0.18		
900(1)		CONCRETING WORKS	cu.m	0.64		
902(1)a		REINFORCING STEEL	kg	195.12		
1003(2)		METAL WORKS	lot	1.00		
SPL-01		OTHER MATERIALS	lot	1.00		
SPL-02		PROJECT SIGNAGE	lot	1.00		
<b>TOTAL PROJECT COST</b>						

*Note: All taxes, contractor's profit and hauling cost are included in unit cost per item.*

\_\_\_\_\_  
NAME AND SIGNATURE OF BIDDER

CRE



REPUBLIC OF THE PHILIPPINES  
**DEPARTMENT OF AGRICULTURE**  
REGIONAL FIELD OFFICE NO.5  
SAN AGUSTIN, PILI, CAMARINES SUR

**PROJECT TITLE**

**P R O P O S E D :**

**SUPPLY, DELIVERY AND INSTALLATION  
OF 13-UNITS RAIN SHEDDTER**

**LOCATION- BICOL REGION**

**PREPARED BY:  
RAED OFFICE**



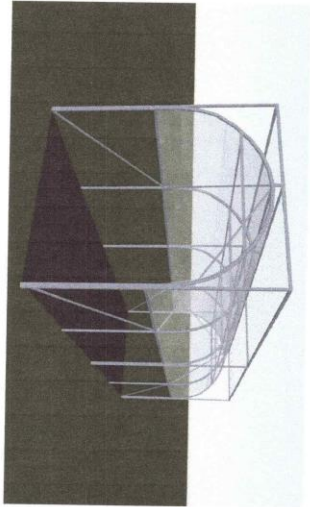

**PERSPECTIVE**

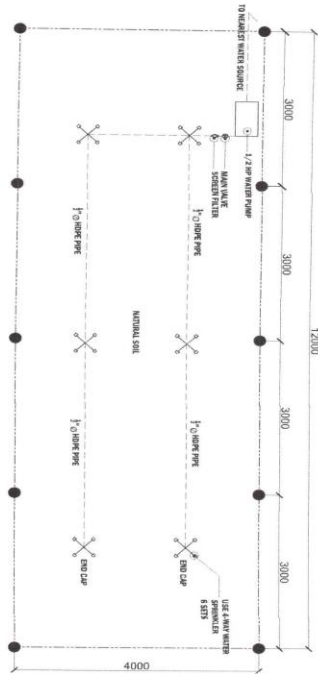

**A PROPOSED LAYOUT**  
SCALE: 1:80

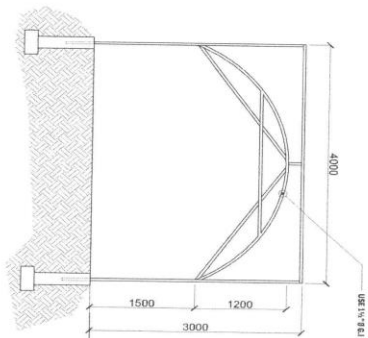

**A FRONT ELEVATION**  
SCALE: 1:70

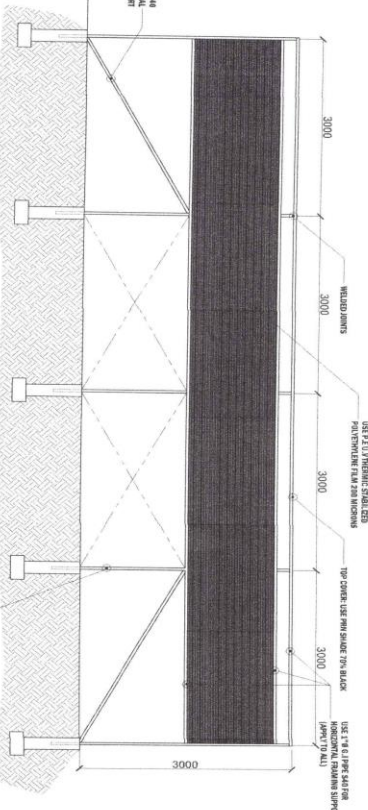

**A TYP. ELEVATION**  
SCALE: 1:70

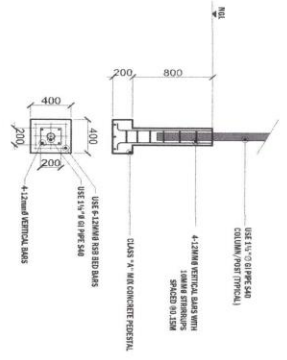

**S TYP. COLUMN FOOTING DETAIL**  
SCALE: 1:70

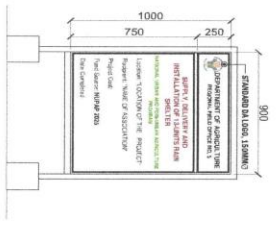

**S PROJECT SIGNAGE DETAIL**  
SCALE: 1:70

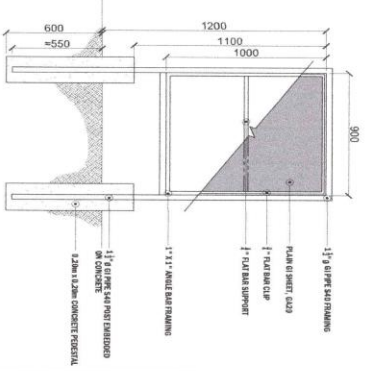

**S PROJECT SIGNAGE DETAIL**  
SCALE: 1:70

REPUBLIC OF THE PHILIPPINES  
DEPARTMENT OF AGRICULTURE  
REGIONAL FIELD OFFICE NO. 5  
SAN AGUSTIN, PUL. DAMAYRES SUR  
CAGAYAN REGION

Prepared by:	Checked by:	Reviewed by:	Revised by:	Registering Agency:	Approved by:
ENGR. GLENDA S. RIVERA, ECUAN CAGAYAN REGION	ENGR. DANIEL B. JR. CAGAYAN REGION	ENGR. LUIS R. BALTAZAR ENHANCED BUREAU	ENGR. JERRY A. BERNIA CAGAYAN REGION	MARY GRACE M. MORALES CAGAYAN REGION	ROSEL P. ORTIZ, MABE CAGAYAN REGION

DATE:	DATE:
SEPTEMBER 2024	SEPTEMBER 2024
AS SHOWN	AS SHOWN



***Section VIII. Checklist of Technical and  
Financial Documents***

# Checklist of Technical and Financial Documents

**Each Bidder shall submit one (1) Original copy of the first and second component of its Bid. The Procuring entity is requesting an additional three (3) hard copies of the bid.**

**Sealed Original, Copy 1, Copy 2& 3 in one (1) Single Envelope**

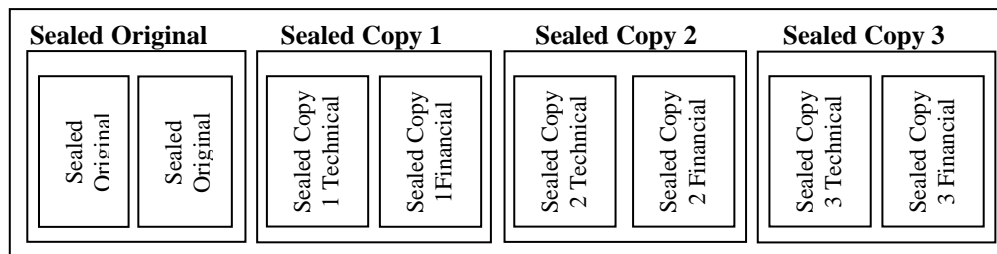

All copies shall be marked Certified True Copy & signed by the bidder or its duly authorized representative.

**Additional instructions:** All copies must be marked with index/ear tabs or side-end tabs to identify the page components and shall be properly addressed to the BAC Chairperson.

## I. TECHNICAL COMPONENT ENVELOPE

### *Class "A" Documents*

#### Legal Documents

- (a) Valid PhilGEPS Registration Certificate (Platinum Membership) (all pages) in accordance with Section 8.5.2 of the IRR;

#### Technical Documents

- (b) Statement of the prospective bidder of all its ongoing government and private contracts, including contracts awarded but not yet started, if any, whether similar or not similar in nature and complexity to the contract to be bid; **and**
- (c) Statement of the bidder's Single Largest Completed Contract (SLCC) similar to the contract to be bid, except under conditions provided for in Sections 23.4.1.3 and 23.4.2.4 of the 2016 revised IRR of RA No. 9184, within the relevant period as provided in the Bidding Documents; **and**
- (d) Original copy of Bid Security. If in the form of a Surety Bond, submit also a certification issued by the Insurance Commission;
- or**
- Original copy of Notarized Bid Securing Declaration; **and**

- (e) Conformity with the Technical Specifications, which may include production/delivery schedule, manpower requirements, and/or after-sales/parts, if applicable; **and**
- (f) Original duly signed Omnibus Sworn Statement (OSS); **and** if applicable, Original Notarized Secretary's Certificate in case of a corporation, partnership, or cooperative; or Original Special Power of Attorney of all members of the joint venture giving full power and authority to its officer to sign the OSS and do acts to represent the Bidder.

Financial Documents

- (g) The prospective bidder's computation of Net Financial Contracting Capacity (NFCC);  
**or**  
A committed Line of Credit from a Universal or Commercial Bank in lieu of its NFCC computation.

***Class "B" Documents***

- (h) If applicable, a duly signed joint venture agreement (JVA) in case the joint venture is already in existence;  
**or**  
duly notarized statements from all the potential joint venture partners stating that they will enter into and abide by the provisions of the JVA in the instance that the bid is successful.

Other documentary requirements under RA No. 9184 (as applicable)

- (i) *[For foreign bidders claiming by reason of their country's extension of reciprocal rights to Filipinos]* Certification from the relevant government office of their country stating that Filipinos are allowed to participate in government procurement activities for the same item or product.
- (j) Certification from the DTI if the Bidder claims preference as a Domestic Bidder or Domestic Entity.

**25 FINANCIAL COMPONENT ENVELOPE**

- (a) Original of duly signed and accomplished Financial Bid Form; **and**
- (b) Original of duly signed and accomplished Price Schedule(s).

***Section IX. BIDDING FORMS***

**BID FORM**

Date : \_\_\_\_\_  
Project Identification No. \_\_\_\_\_ :

To: *[name and address of Procuring Entity]*

Having examined the Philippine Bidding Documents (PBDs) including the Supplemental or Bid Bulletin Numbers *[insert numbers]*, the receipt of which is hereby duly acknowledged, we, the undersigned, offer to *[supply/deliver/perform]* *[description of the Goods]* in conformity with the said PBDs for the sum of *[total Bid amount in words and figures]* or the total calculated bid price, as evaluated and corrected for computational errors, and other bid modifications in accordance with the Price Schedules attached herewith and made part of this Bid. The total bid price includes the cost of all taxes, such as, but not limited to: *[specify the applicable taxes, e.g. (i) value added tax (VAT), (ii) income tax, (iii) local taxes, and (iv) other fiscal levies and duties]*, which are itemized herein or in the Price Schedules,

If our Bid is accepted, we undertake:

- a. to deliver the goods in accordance with the delivery schedule specified in the Schedule of Requirements of the Philippine Bidding Documents (PBDs);
- b. to provide a performance security in the form, amounts, and within the times prescribed in the PBDs;
- c. to abide by the Bid Validity Period specified in the PBDs and it shall remain binding upon us at any time before the expiration of that period.

*[Insert this paragraph if Foreign-Assisted Project with the Development Partner: Commissions or gratuities, if any, paid or to be paid by us to agents relating to this Bid,*

and to contract execution if we are awarded the contract, are listed below:

Name and address of agent	Amount and Purpose of Commission or gratuity
_____	_____
_____	_____
_____	_____

(if none, state "None" ) ]

Until a formal Contract is prepared and executed, this Bid, together with your written acceptance thereof and your Notice of Award, shall be binding upon us.

We understand that you are not bound to accept the Lowest Calculated Bid or any Bid you may receive.

We certify/confirm that we comply with the eligibility requirements pursuant to the PBDs.

The undersigned is authorized to submit the bid on behalf of *[name of the bidder]* as evidenced by the attached *[state the written authority]*.

*GPPB Resolution No. 16-2020, dated 16 September 2020*

We acknowledge that failure to sign each and every page of this Bid Form, including the attached Schedule of Prices, shall be a ground for the rejection of our bid.

Name: \_\_\_\_\_

Legal capacity: \_\_\_\_\_

Signature: \_\_\_\_\_

Duly authorized to sign the Bid for and behalf of: \_\_\_\_\_

Date: \_\_\_\_\_

*GPPB Resolution No. 16-2020, dated 16 September 2020*

**Price Schedule for Goods Offered from Abroad**  
*[shall be submitted with the Bid if bidder is offering goods from Abroad]*

**For Goods Offered from Abroad**

Name of Bidder \_\_\_\_\_ Project ID No. \_\_\_\_\_ Page \_\_\_ of \_\_\_

1	2	3	4	5	6	7	8	9
Item	Description	Country of origin	Quantity	Unit price CIF port of entry (specify port) or CIP named place  (specify border point or place of destination)	Total CIF or CIP price per item  (col. 4 x 5)	Unit Price Delivered Duty Unpaid (DDU)	Unit price Delivered Duty Paid (DDP)	Total Price delivered DDP (col 4 x 8)

Name: \_\_\_\_\_

Legal Capacity: \_\_\_\_\_

Signature: \_\_\_\_\_

Duly authorized to sign the Bid for and behalf of: \_\_\_\_\_

**Price Schedule for Goods Offered from Within the Philippines**  
*[shall be submitted with the Bid if bidder is offering goods from within the Philippines]*

**For Goods Offered from Within the Philippines**

Name of Bidder \_\_\_\_\_ Project ID No. \_\_\_\_\_ Page \_\_\_ of \_\_\_

1	2	3	4	5	6	7	8	9	10
Item	Description	Country of origin	Quantity	Unit price EXW per item	Transportation and all other costs incidental to delivery, per item	Sales and other taxes payable if Contract is awarded, per item	Cost of Incidental Services, if applicable, per item	Total Price, per unit  (col 5+6+7+8)	Total Price delivered Final Destination  (col 9) x (col 4)
<b>1</b>	<b>Supply, Delivery and Installation of Rainshelter in Bicol Region</b>  Albay		6 units						
<b>TOTAL FOR LOT 1</b>									
<b>2</b>	<b>Supply, Delivery and Installation of Rainshelter in Bicol Region</b>  Camarines Sur		3 units						
<b>TOTAL FOR LOT 2</b>									
<b>3</b>	<b>Supply, Delivery and Installation of Rainshelter in Bicol Region</b>  Camarines Norte		1 unit						
<b>TOTAL FOR LOT 3</b>									
<b>4</b>	<b>Supply, Delivery and Installation of Rainshelter in Bicol Region</b>  Sorsogon		3 units						
<b>TOTAL FOR LOT 4</b>									
<b>GRAND TOTAL</b>									

Name: \_\_\_\_\_

Legal Capacity: \_\_\_\_\_

Signature: \_\_\_\_\_

Duly authorized to sign the Bid for and behalf of: \_\_\_\_\_



**Bid Securing Declaration Form**  
*[shall be submitted with the Bid if bidder opts to provide this form of bid security]*

---

REPUBLIC OF THE PHILIPPINES)  
CITY OF \_\_\_\_\_) S.S.

**BID SECURING DECLARATION**  
**Project Identification No.: *[Insert number]***

To: *[Insert name and address of the Procuring Entity]*

I/We, the undersigned, declare that:

1. I/We understand that, according to your conditions, bids must be supported by a Bid Security, which may be in the form of a Bid Securing Declaration.
2. I/We accept that: (a) I/we will be automatically disqualified from bidding for any procurement contract with any procuring entity for a period of two (2) years upon receipt of your Blacklisting Order; and, (b) I/we will pay the applicable fine provided under Section 6 of the Guidelines on the Use of Bid Securing Declaration, within fifteen (15) days from receipt of the written demand by the procuring entity for the commission of acts resulting to the enforcement of the bid securing declaration under Sections 23.1(b), 34.2, 40.1 and 69.1, except 69.1(f), of the IRR of RA No. 9184; without prejudice to other legal action the government may undertake.
3. I/We understand that this Bid Securing Declaration shall cease to be valid on the following circumstances:
  - a. Upon expiration of the bid validity period, or any extension thereof pursuant to your request;
  - b. I am/we are declared ineligible or post-disqualified upon receipt of your notice to such effect, and (i) I/we failed to timely file a request for reconsideration or (ii) I/we filed a waiver to avail of said right; and
  - c. I am/we are declared the bidder with the Lowest Calculated Responsive Bid, and I/we have furnished the performance security and signed the Contract.

IN WITNESS WHEREOF, I/We have hereunto set my/our hand/s this \_\_\_\_ day of *[month]* *[year]* at *[place of execution]*.

*[Insert NAME OF BIDDER OR ITS AUTHORIZED REPRESENTATIVE]*

*[Insert signatory's legal capacity]*

Affiant

**Jurat**

*[Format shall be based on the latest Rules on Notarial Practice]*

**Contract Agreement Form for the Procurement of Goods (Revised)**  
***[Not required to be submitted with the Bid, but it shall be submitted within ten (10) days after receiving the Notice of Award]***

---

**CONTRACT AGREEMENT**

THIS AGREEMENT made the \_\_\_\_\_ day of \_\_\_\_\_ 20\_\_\_\_ between [name of PROCURING ENTITY] of the Philippines (hereinafter called “the Entity”) of the one part and [name of Supplier] of [city and country of Supplier] (hereinafter called “the Supplier”) of the other part;

WHEREAS, the Entity invited Bids for certain goods and ancillary services, particularly [brief description of goods and services] and has accepted a Bid by the Supplier for the supply of those goods and services in the sum of [*contract price in words and figures in specified currency*] (hereinafter called “the Contract Price”).

NOW THIS AGREEMENT WITNESSETH AS FOLLOWS:

1. In this Agreement words and expressions shall have the same meanings as are respectively assigned to them in the Conditions of Contract referred to.
2. The following documents as required by the 2016 revised Implementing Rules and Regulations of Republic Act No. 9184 shall be deemed to form and be read and construed as integral part of this Agreement, *viz.*:
  - i. Philippine Bidding Documents (PBDs);
    - i. Schedule of Requirements;
    - ii. Technical Specifications;
    - iii. General and Special Conditions of Contract; and
    - iv. Supplemental or Bid Bulletins, if any
  - ii. Winning bidder’s bid, including the Eligibility requirements, Technical and Financial Proposals, and all other documents or statements submitted;  
  
Bid form, including all the documents/statements contained in the Bidder’s bidding envelopes, as annexes, and all other documents submitted (e.g., Bidder’s response to request for clarifications on the bid), including corrections to the bid, if any, resulting from the Procuring Entity’s bid evaluation;
  - iii. Performance Security;
  - iv. Notice of Award of Contract; and the Bidder’s conforme thereto; and
  - v. Other contract documents that may be required by existing laws and/or the Procuring Entity concerned in the PBDs. **Winning bidder agrees that additional contract documents or information prescribed by the GPPB that are subsequently required for submission after the contract execution, such as the Notice to Proceed, Variation Orders, and Warranty Security, shall likewise form part of the Contract.**
3. In consideration for the sum of [*total contract price in words and figures*] or such other sums as may be ascertained, [*Named of the bidder*] agrees to [*state the object of the contract*] in accordance with his/her/its Bid.

4. The *[Name of the procuring entity]* agrees to pay the above-mentioned sum in accordance with the terms of the Bidding.

IN WITNESS whereof the parties hereto have caused this Agreement to be executed in accordance with the laws of the Republic of the Philippines on the day and year first above written.

*[Insert Name and Signature]*

*[Insert Name and Signature]*

*[Insert Signatory's Legal Capacity]*

*[Insert Signatory's Legal Capacity]*

*for:*

*for:*

*[Insert Procuring Entity]*

*[Insert Name of Supplier]*

**Acknowledgment**

*[Format shall be based on the latest Rules on Notarial Practice]*

**Omnibus Sworn Statement (Revised)**  
***[shall be submitted with the Bid]***

---

REPUBLIC OF THE PHILIPPINES )  
CITY/MUNICIPALITY OF \_\_\_\_\_ ) S.S.

**AFFIDAVIT**

I, [Name of Affiant], of legal age, [Civil Status], [Nationality], and residing at [Address of Affiant], after having been duly sworn in accordance with law, do hereby depose and state that:

1. *[Select one, delete the other:]*

*[If a sole proprietorship:]* I am the sole proprietor or authorized representative of [Name of Bidder] with office address at [address of Bidder];

*[If a partnership, corporation, cooperative, or joint venture:]* I am the duly authorized and designated representative of [Name of Bidder] with office address at [address of Bidder];

2. *[Select one, delete the other:]*

*[If a sole proprietorship:]* As the owner and sole proprietor, or authorized representative of [Name of Bidder], I have full power and authority to do, execute and perform any and all acts necessary to participate, submit the bid, and to sign and execute the ensuing contract for [Name of the Project] of the [Name of the Procuring Entity], as shown in the attached duly notarized Special Power of Attorney;

*[If a partnership, corporation, cooperative, or joint venture:]* I am granted full power and authority to do, execute and perform any and all acts necessary to participate, submit the bid, and to sign and execute the ensuing contract for [Name of the Project] of the [Name of the Procuring Entity], as shown in the attached [state title of attached document showing proof of authorization (e.g., duly notarized Secretary's Certificate, Board/Partnership Resolution, or Special Power of Attorney, whichever is applicable)];

3. [Name of Bidder] is not "blacklisted" or barred from bidding by the Government of the Philippines or any of its agencies, offices, corporations, or Local Government Units, foreign government/foreign or international financing institution whose blacklisting rules have been recognized by the Government Procurement Policy Board, **by itself or by relation, membership, association, affiliation, or controlling interest with another blacklisted person or entity as defined and provided for in the Uniform Guidelines on Blacklisting;**

4. Each of the documents submitted in satisfaction of the bidding requirements is an authentic copy of the original, complete, and all statements and information provided therein are true and correct;

5. [Name of Bidder] is authorizing the Head of the Procuring Entity or its duly authorized representative(s) to verify all the documents submitted;

6. *[Select one, delete the rest:]*

*[If a sole proprietorship:]* The owner or sole proprietor is not related to the Head of the Procuring Entity, members of the Bids and Awards Committee (BAC), the Technical

Working Group, and the BAC Secretariat, the head of the Project Management Office or the end-user unit, and the project consultants by consanguinity or affinity up to the third civil degree;

*[If a partnership or cooperative:]* None of the officers and members of *[Name of Bidder]* is related to the Head of the Procuring Entity, members of the Bids and Awards Committee (BAC), the Technical Working Group, and the BAC Secretariat, the head of the Project Management Office or the end-user unit, and the project consultants by consanguinity or affinity up to the third civil degree;

*[If a corporation or joint venture:]* None of the officers, directors, and controlling stockholders of *[Name of Bidder]* is related to the Head of the Procuring Entity, members of the Bids and Awards Committee (BAC), the Technical Working Group, and the BAC Secretariat, the head of the Project Management Office or the end-user unit, and the project consultants by consanguinity or affinity up to the third civil degree;

7. *[Name of Bidder]* complies with existing labor laws and standards; and
8. *[Name of Bidder]* is aware of and has undertaken the responsibilities as a Bidder in compliance with the Philippine Bidding Documents, which includes:
  - a. Carefully examining all of the Bidding Documents;
  - b. Acknowledging all conditions, local or otherwise, affecting the implementation of the Contract;
  - c. Making an estimate of the facilities available and needed for the contract to be bid, if any; and
  - d. Inquiring or securing Supplemental/Bid Bulletin(s) issued for the *[Name of the Project]*.
9. *[Name of Bidder]* did not give or pay directly or indirectly, any commission, amount, fee, or any form of consideration, pecuniary or otherwise, to any person or official, personnel or representative of the government in relation to any procurement project or activity.
10. **In case advance payment was made or given, failure to perform or deliver any of the obligations and undertakings in the contract shall be sufficient grounds to constitute criminal liability for Swindling (Estafa) or the commission of fraud with unfaithfulness or abuse of confidence through misappropriating or converting any payment received by a person or entity under an obligation involving the duty to deliver certain goods or services, to the prejudice of the public and the government of the Philippines pursuant to Article 315 of Act No. 3815 s. 1930, as amended, or the Revised Penal Code.**

IN WITNESS WHEREOF, I have hereunto set my hand this \_\_\_ day of \_\_\_, 20\_\_ at \_\_\_\_\_, Philippines.

*[Insert NAME OF BIDDER OR ITS AUTHORIZED REPRESENTATIVE]*

*[Insert signatory's legal capacity]*

Affiant

**[Jurat]**

*[Format shall be based on the latest Rules on Notarial Practice]*

